

2005 Presentation Folder and
Promotional Packaging Catalog



Great presentations start with...

FSI Products
Line

Table of Contents

Welcome to our catalog of Presentation Folders and Promotional Packaging Products!

This catalog has been organized to provide you with an efficient way to identify products that will help you accomplish your presentation goals. You will find a myriad of designs and ideas all focused on making your presentation a success! And if you don't find the exact die line you are looking for you can rely on our custom capabilities. Please call Customer Service for assistance.

● Large Folders	1 - 5
● Capacity Folders	6 - 7
● Three Panel Folders	8 - 9
● Unique Folders	10 - 11
● Legal Folders	12 - 13
● Mini Folders	14 - 17
● Hotel Key Folders	18 - 19
● Report Covers	20
● Tax Folders	21
● File Folders	22 - 24
● Paper Wallets	25 - 26
● Portfolios	27 - 29
● Inserts	29
● Photo Frames	30 - 31
● Certificate Holders	32
● CD and DVD	33 - 35
● Promotional Packaging	36 - 39
● Custom Designs	40
● Financial Products	40
● Papers and Foils	41
● Important information	42 - 44
● Preflight Checklist	45

Large Folders

Image! Your image! Few things are more important in the marketing of your business. Only trust your image to the experts. You need Presentation Folders that:

- Reflect the **quality of work** you provide
- Enhance the **importance** of your documents
- Maintain the **professional image** of your firm
- Increase the **credibility** of your materials
- Ensure materials are kept

and...

Differentiate you from the competition!



So, whether you use folders for Sales Proposals, Seminar Kits, New Patient Packets, Contracts, New Employee Packets, New Home / Development Plans, Press Release Kits, 401(K) Documents, or anything else, you can count on us to produce folders which are sure to have the impact you want!

Cost Per Each	250	500	1M	1500	2M	2500	3M	4M	5M	10M
Printed 1 color, 1 side	2.15	1.58	1.26	1.06	1.02	.94	.90	.84	.80	.66
Printed 2 colors, 1 side	2.87	1.96	1.40	1.19	1.10	1.00	.96	.92	.90	.70
Printed 4 color process, 1 side	7.10	3.66	2.10	1.60	1.44	1.34	1.22	1.08	1.00	.86
Foil stamped 1 color (24 sq. in.)	2.61	1.76	1.33	1.20	1.16	1.08	1.05	.96	.92	.76
Emboss (24 sq. in.)	2.74	1.83	1.37	1.22	1.18	1.09	1.06	.98	.94	.76
Add To Base	250	500	1M	1500	2M	2500	3M	4M	5M	10M
Additional print	+.53	+.30	+.19	+.15	+.13	+.12	+.10	+.09	+.08	+.06
Additional foil	+.65	+.37	+.23	+.19	+.17	+.15	+.14	+.11	+.10	+.07
Additional emboss	+.65	+.37	+.23	+.19	+.17	+.15	+.14	+.11	+.10	+.07
Additional varnish/aqueous	+.75	+.39	+.22	+.17	+.14	+.12	+.11	+.10	+.09	+.07
Heavy ink coverage	+.75	+.39	+.22	+.17	+.14	+.12	+.11	+.10	+.09	+.07
Spine prong attachment	+.76	+.76	+.76	+.76	+.76	+.76	+.76	+.76	+.76	+.76
Deluxe paper stock	+.19	+.15	+.14	+.14	+.14	+.14	+.14	+.14	+.14	+.14
Premium paper stock	+.45	+.38	+.34	+.33	+.33	+.33	+.33	+.33	+.33	+.33
Deduct From Base	250	500	1M	1500	2M	2500	3M	4M	5M	10M
Value paper stock	-.14	-.12	-.11	-.10	-.10	-.10	-.10	-.10	-.10	-.10
SS106 folder styles	-.10	-.10	-.10	-.10	-.10	-.10	-.10	-.10	-.10	-.04

List prices effective January 2005

FOB: Wisconsin, Class P

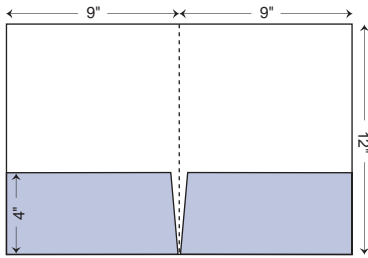
Production Notes

Important Information: please refer to pages 42 through 44 for all relevant information regarding the production of your order.

Pricing: established using base stocks. Refer to the "Stock Selection Guide" or see page 41.

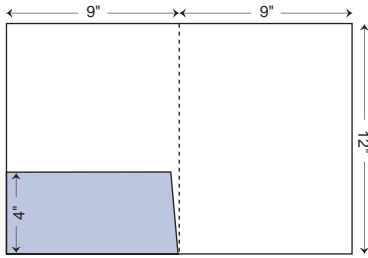
Production Time: 5 working days on Styles SS106, SS106LP and SS106RP. This applies to foil stamping or printing up to 4 PMS colors with 35% total ink coverage, after all items are received including credit and proof approval. Allow 7 working days on emboss, four-color process and all other Large Folder styles. Orders in by 1PM CST will be considered day one. Multiple processes will require additional working days.

Large Folders



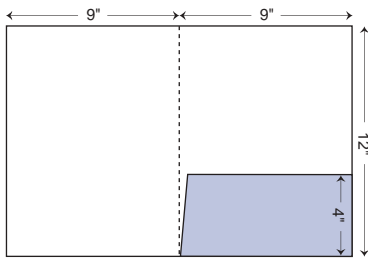
SS106

- Pockets are glued
- See page 42 for pocket slit options
- Most popular slit option is four-corner horizontal slits
- See price chart for deduction



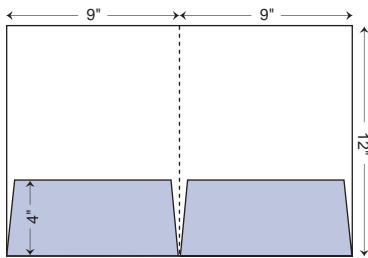
SS106LP

- Pocket is glued
- See page 42 for pocket slit options
- See price chart for deduction



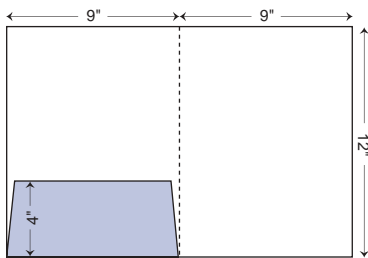
SS106RP

- Pocket is glued
- See page 42 for pocket slit options
- See price chart for deduction



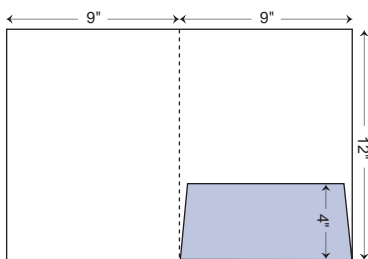
SS1371

- Pockets are unglued
- See page 42 for pocket slit options



SS1371LP

- Pocket is unglued
- See page 42 for pocket slit options

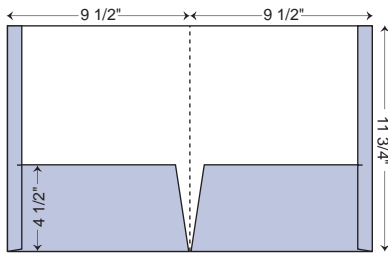


SS1371RP

- Pocket is unglued
- See page 42 for pocket slit options

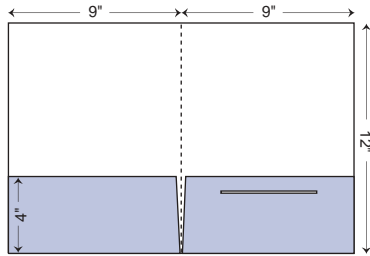


Large Folders



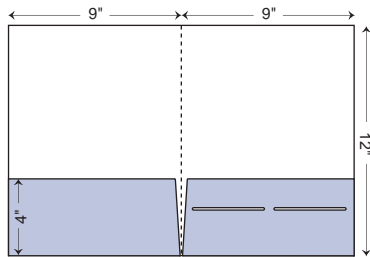
DD116

- Pockets are glued
- 3/4" reinforced edges
- See page 42 for pocket slit options
- Call for pricing on final folding



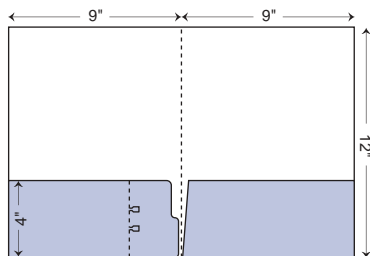
SS973

- Pockets are glued
- See page 42 for left pocket slit options
- 5" slot standard in right pocket as shown
- **Ideal for holding CD's or DVD's**



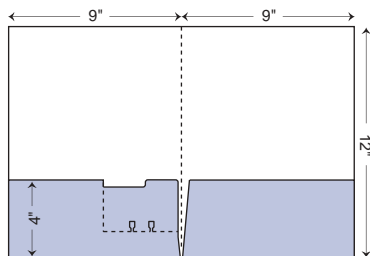
SS1855

- Pockets are glued
- See page 42 for left pocket slit options
- Two 3 3/4" slots standard in right pocket as shown
- **Ideal for brochures, rate cards, directories, event calenders, etc.**



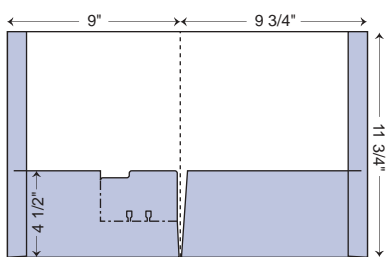
SS1572

- Pockets are glued
- Includes perforated rolodex card
- See page 42 for right pocket slit options



SS889

- Pockets are glued
- Includes perforated rolodex card
- See page 42 for right pocket slit options

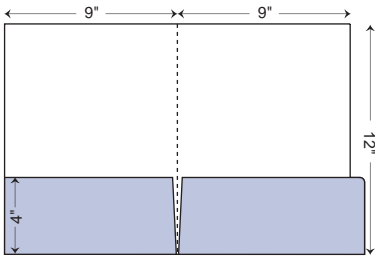


DD1108

- Pockets are glued
- 1" reinforced edges with 3/4" tab extension on right panel
- Includes perforated rolodex card
- See page 42 for right pocket slit options
- Call for pricing on final folding

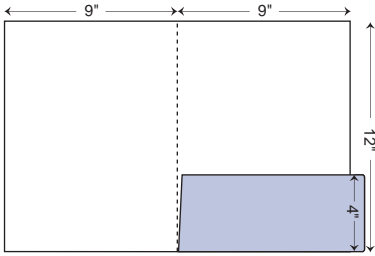


Large Folders



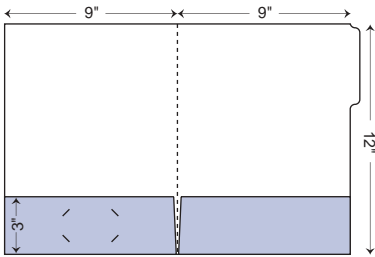
SS2900

- Pockets are glued
- Right pocket has double thick 3/4" tab extension
- See page 42 for pocket slit options
- **Ideal for filing**



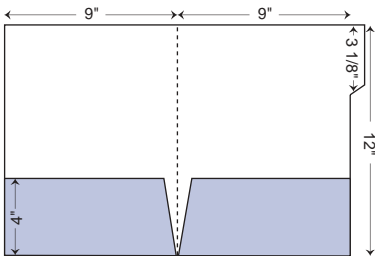
SS171

- Pocket is glued
- Right pocket has double thick 3/4" tab extension
- See page 42 for pocket slit options
- **Ideal for filing**



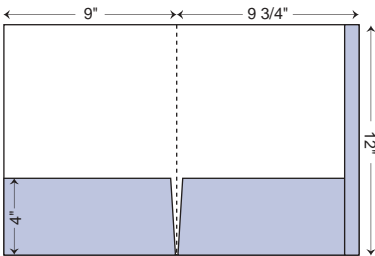
DD2669

- Pockets are glued
- Right panel has 1/2" tab extension
- Pocket slits standard as shown
- **Ideal for filing**



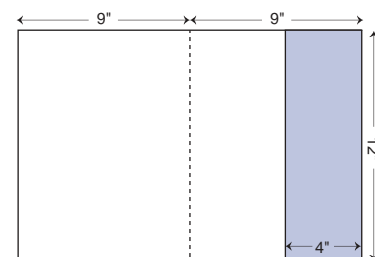
DD314

- Pockets are glued
- Right panel has 3/4" tab extension
- See page 42 for pocket slit options
- **Ideal for filing**



DD349

- Pockets are glued
- 3/4" reinforced edge and tab extension on right panel
- See page 42 for pocket slit options
- Call for pricing on final folding

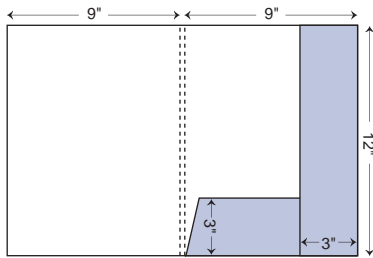


DD983

- Pocket is glued
- See page 42 for pocket slit options
- Call for pricing on final folding

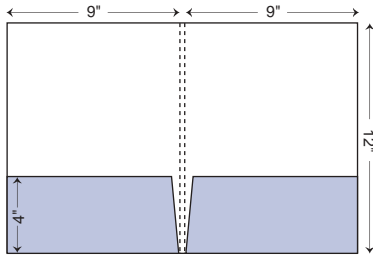


Large Folders



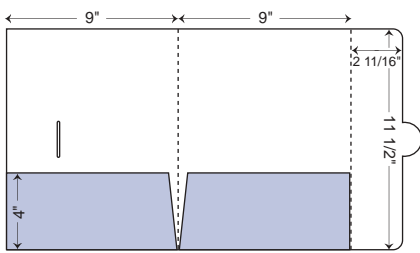
SS2241

- Pockets are unglued
- 1/4" backbone provides additional capacity
- Pocket slits not available
- Call for pricing on final folding



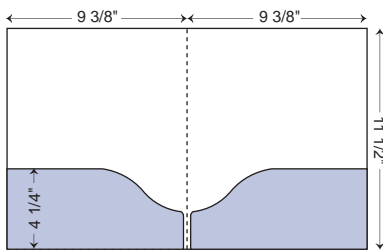
SS433

- Pockets are glued
- 3/8" backbone provides additional capacity
- See page 42 for pocket slit options



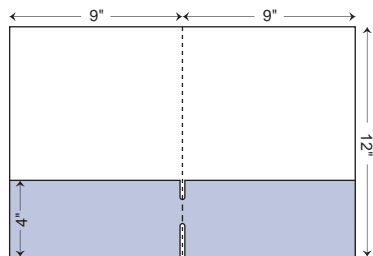
DD2147

- Pockets are unglued
- Closing flap tucks into slit on front
- See page 42 for pocket slit options
- Call for pricing on final folding



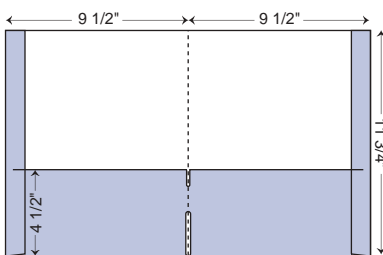
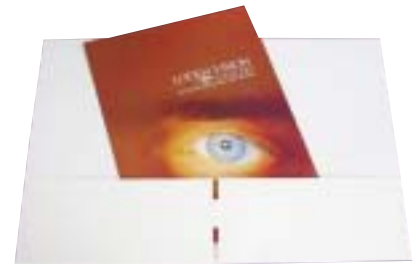
SS3397

- Pockets are glued
- See page 42 for pocket slit options



DD460

- Continuous pocket, glued at outer edges
- See page 42 for pocket slit options



DD580

- 1" reinforced edges
- Continuous pocket, glued at outer edges
- See page 42 for pocket slit options
- Call for pricing on final folding



Capacity Folders

Speak volumes with our Capacity Folders! And be sure your brand identity speaks volumes too. No need to compromise when you can have world-class folders to showcase your important information.

Featured styles include expandable and box pockets with various levels of capacity to accommodate your needs for presenting large amounts of information. Use these folders for lease agreements, new employee information, real estate documents, technical proposals, seminars and more. You're sure to be in a class by yourself!



Cost Per Each	250	500	1M	1500	2M	2500	3M	4M	5M	10M
Printed 1 color, 1 side	2.23	1.78	1.44	1.22	1.16	1.06	.98	.91	.86	.70
Printed 2 colors, 1 side	3.27	2.18	1.58	1.35	1.24	1.12	1.04	.99	.96	.74
Printed 4 color process, 1 side	7.40	3.86	2.28	1.76	1.58	1.46	1.30	1.15	1.06	.90
Foil stamped 1 color (24 sq. in.)	2.91	1.96	1.51	1.35	1.30	1.20	1.13	1.03	.98	.80
Emboss (24 sq. in.)	3.04	2.03	1.55	1.38	1.32	1.21	1.14	1.05	1.00	.80
Add To Base	250	500	1M	1500	2M	2500	3M	4M	5M	10M
Additional print	+.53	+.30	+.19	+.15	+.13	+.12	+.10	+.09	+.08	+.06
Additional foil	+.65	+.37	+.23	+.19	+.17	+.15	+.14	+.11	+.10	+.07
Additional emboss	+.65	+.37	+.23	+.19	+.17	+.15	+.14	+.11	+.10	+.07
Additional varnish/aqueous	+.75	+.39	+.22	+.17	+.14	+.12	+.11	+.10	+.09	+.07
Heavy ink coverage	+.75	+.39	+.22	+.17	+.14	+.12	+.11	+.10	+.09	+.07
Additional charge - DD927	+.54	+.54	+.54	+.54	+.52	+.52	+.52	+.46	+.46	+.42
Additional charge - DD1233	+.84	+.84	+.84	+.84	+.58	+.58	+.58	+.52	+.52	+.44
Deluxe paper stock	+.19	+.15	+.14	+.14	+.14	+.14	+.14	+.14	+.14	+.14
Premium paper stock	+.45	+.38	+.34	+.33	+.33	+.33	+.33	+.33	+.33	+.33
Deduct From Base	250	500	1M	1500	2M	2500	3M	4M	5M	10M
Value paper stock	-.14	-.12	-.11	-.10	-.10	-.10	-.10	-.10	-.10	-.10

List prices effective January 2005

FOB: Wisconsin, Class P

Production Notes

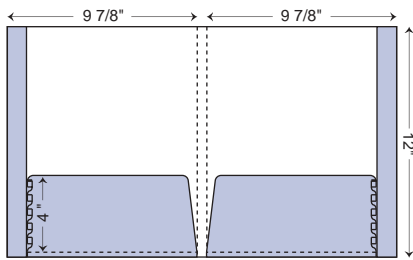
Final Folding: Call for pricing on final folding on all Capacity Folder styles.

Important Information: please refer to pages 42 through 44 for all relevant information regarding the production of your order.

Pricing: established using base stocks. Refer to the "Stock Selection Guide" or see page 41.

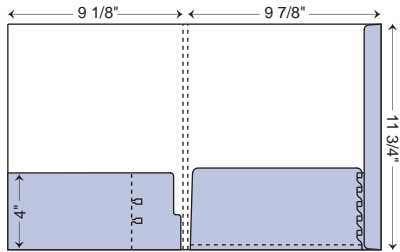
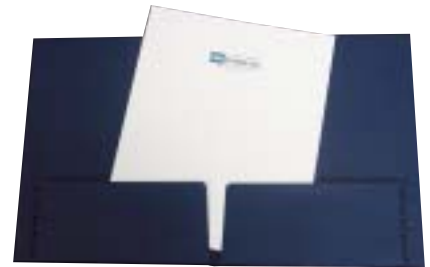
Production Time: 10 working days on all Capacity Folder styles, after all items are received; with credit and proof approval. Orders in by 1PM CST will be considered day one. Multiple processes will require additional working days. Need it faster? Call Customer Service and we'll check our production schedule to expedite your order.

Capacity Folders



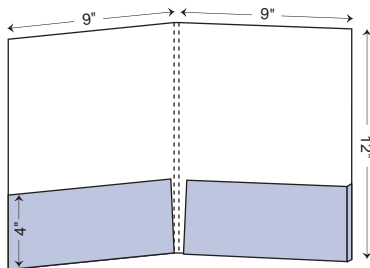
DD1244

- Pockets are glued
- 1/2" backbone provides additional capacity
- Pockets expand 1/4" deep for extra capacity
- 1" reinforced edges
- See page 42 for pocket slit options



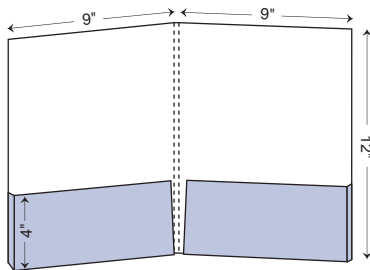
DD1304

- Pockets are glued
- 1/4" backbone provides additional capacity
- Right pocket expands 1/4" deep
- Includes perforated rolodex card
- 1" reinforced edge with 3/4" tab extension on right panel
- See page 42 for right pocket slit options



DD927

- Pockets are glued
- 1/4" backbone provides additional capacity
- 1/4" deep box pocket on right panel
- See page 42 for pocket slit options
- See price chart for additional charges



DD1233

- Pockets are glued
- 1/2" backbone provides additional capacity
- 1/4" deep box pockets
- See page 42 for pocket slit options
- See price chart for additional charges



You'll find this catalog to be the most complete and comprehensive selection of Presentation Folders and Promotional Packaging in the industry. Refer to the Table of Contents for a complete listing of all product categories. You will find Large Folders, Mini Folders, Paper Wallets, Hotel Key Folders and everything in between. So, whatever your presentation or marketing needs, you are certain to find a solution that will help you reach your business goals.

Three Panel Folders

Organize and present all your information with our Three Panel Folders! Styles include single or three pocket designs and are offered in sizes ranging from 4" x 9" to 9" x 12" when closed. No matter how much information you have it's no problem for these folders...use them to organize seminar materials, owners manuals and warranty information, new employee and 401(K) materials, estate planning information, capabilities pieces and whatever you can dream up.



Cost Per Each	250	500	1M	1500	2M	2500	3M	4M	5M	10M
Printed 1 color, 1 side	5.14	3.06	2.32	2.12	2.02	1.56	1.51	1.44	1.40	1.22
Printed 2 colors, 1 side	6.31	3.72	2.64	2.32	2.16	1.70	1.61	1.50	1.46	1.27
Printed 4 color process, 1 side	10.77	5.14	3.40	2.80	2.56	2.00	1.89	1.76	1.68	1.41
Foil stamped 1 color (24 sq. in.)	5.39	4.10	3.06	2.74	2.58	2.10	2.04	1.94	1.88	1.56
Emboss (24 sq. in.)	5.54	4.17	3.10	2.76	2.60	2.11	2.05	1.95	1.89	1.56
Add To Base	250	500	1M	1500	2M	2500	3M	4M	5M	10M
Additional print	+1.54	+.81	+.43	+.31	+.24	+.21	+.18	+.16	+.14	+.10
Additional varnish/aqueous	+1.69	+.89	+.48	+.34	+.27	+.23	+.20	+.17	+.15	+.11
Heavy ink coverage	+1.69	+.89	+.48	+.34	+.27	+.23	+.20	+.17	+.15	+.11
Deluxe paper stock	+.37	+.30	+.27	+.26	+.26	+.26	+.26	+.26	+.26	+.26
Premium paper stock	+.88	+.70	+.62	+.62	+.62	+.62	+.62	+.62	+.62	+.62
Deduct From Base	250	500	1M	1500	2M	2500	3M	4M	5M	10M
Value paper stock	-.25	-.22	-.20	-.19	-.19	-.19	-.19	-.19	-.19	-.19

List prices effective January 2005

FOB: Wisconsin, Class P

Production Notes

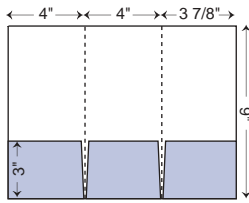
Final Folding: Call for pricing on final folding on all Three Panel Folder styles.

Important Information: please refer to pages 42 through 44 for all relevant information regarding the production of your order.

Pricing: established using base stocks. Refer to the "Stock Selection Guide" or see page 41.

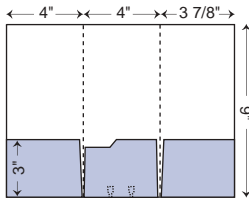
Production Time: 10 working days on all Three Panel Folder styles, after all items are received; with credit and proof approval. Orders in by 1PM CST will be considered day one. Multiple processes will require additional working days. Need it faster? Call Customer Service and we'll check our production schedule to expedite your order.

Three Panel Folders



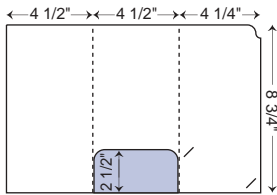
MT807

- Two outside pockets are glued
- Center pocket is unglued
- See page 42 for pocket slit options
- **Call for pricing**



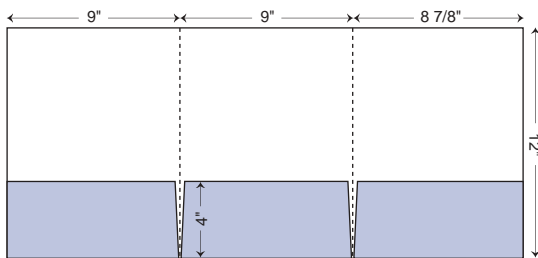
MT1422

- Two outside pockets are glued
- Includes perforated rolodex card
- Pocket slits not available
- **Call for pricing**



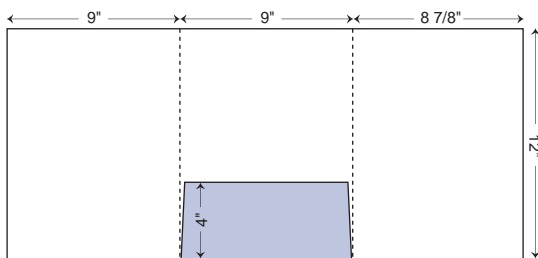
MT2845

- Pocket is unglued
- Decorative edge at top corner
- Slits standard as shown on right panel
- **Call for pricing**



TF1392

- Two outside pockets are glued
- See page 42 for pocket slit options



TF3066

- Unglued center pocket
- See page 42 for pocket slit options



Whenever you need to make proposals, provide information, convey a message or hold important documents. You want it to have ...Impact!

Presentation Folders provide impact! Get the results you need to move your business to the next level with our Presentation Folder Line. The introductory paragraphs and photos in each product section provide examples and ideas of how other businesses have used folders to get the impact they need for their business. Take the opportunity to do the same things for your company with our Presentation Folder Line.

Unique Folders

Your company's unique...shouldn't your folder reflect that uniqueness? Our Unique Folders are anything but ordinary and will surely help you make an impact with your presentations! Folder styles are offered in 9" x 12" sizes when closed and they have fun and functional pocket designs that will certainly get noticed.



Cost Per Each	250	500	1M	1500	2M	2500	3M	4M	5M	10M
Printed 1 color, 1 side	2.34	2.03	1.50	1.31	1.25	1.18	1.15	1.08	1.03	.86
Printed 2 colors, 1 side	3.16	2.64	1.82	1.56	1.43	1.32	1.27	1.18	1.08	.90
Printed 4 color process, 1 side	7.60	4.24	2.63	2.12	1.86	1.70	1.60	1.41	1.34	1.03
Foil stamped 1 color (24 sq. in.)	2.84	2.20	1.70	1.52	1.41	1.34	1.30	1.23	1.18	.99
Emboss (24 sq. in.)	2.98	2.28	1.74	1.54	1.43	1.35	1.31	1.24	1.19	1.01
Add To Base	250	500	1M	1500	2M	2500	3M	4M	5M	10M
Additional print	+.53	+.30	+.19	+.15	+.13	+.12	+.10	+.09	+.08	+.06
Additional foil	+.65	+.37	+.23	+.19	+.17	+.15	+.14	+.11	+.10	+.07
Additional emboss	+.65	+.37	+.23	+.19	+.17	+.15	+.14	+.11	+.10	+.07
Additional varnish/aqueous	+.75	+.39	+.22	+.17	+.14	+.12	+.11	+.10	+.09	+.07
Heavy ink coverage	+.75	+.39	+.22	+.17	+.14	+.12	+.11	+.10	+.09	+.07
Deluxe paper stock	+.20	+.16	+.15	+.15	+.15	+.15	+.15	+.15	+.15	+.15
Premium paper stock	+.47	+.40	+.36	+.36	+.36	+.36	+.36	+.36	+.36	+.36
Deduct From Base	250	500	1M	1500	2M	2500	3M	4M	5M	10M
Value paper stock	-.15	-.12	-.11	-.11	-.11	-.11	-.11	-.11	-.11	-.11

List prices effective January 2005

FOB: Wisconsin, Class P

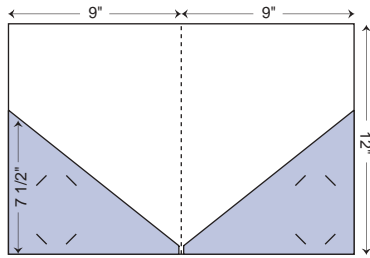
Production Notes

Important Information: please refer to pages 42 through 44 for all relevant information regarding the production of your order.

Pricing: established using base stocks. Refer to the "Stock Selection Guide" or see page 41.

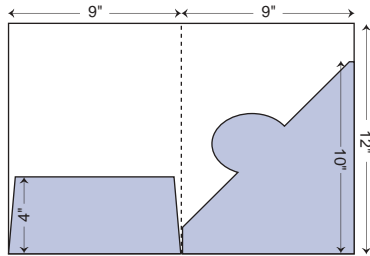
Production Time: 7 working days on all Unique Folder styles, after all items are received; with credit and proof approval. Orders in by 1PM CST will be considered day one. Multiple processes will require additional working days.

Unique Folders



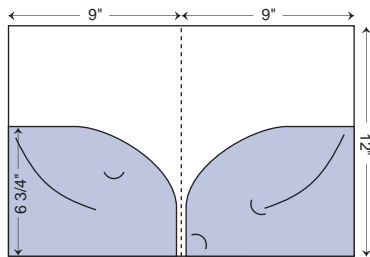
LS2198

- Pockets are glued
- Diagonal pockets add visual interest
- Pocket slits standard as shown
- **Ideal for vertical business cards**



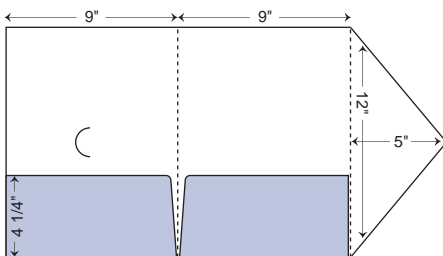
LS1292

- Right pocket is glued
- Left pocket is unglued
- See page 42 for pocket slit options



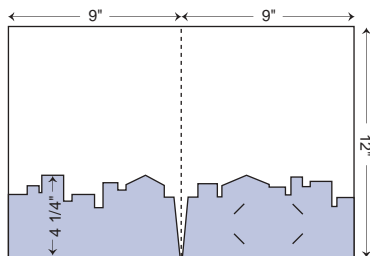
LS2892

- Pockets are glued
- Pocket slits standard as shown
- **Ideal for holding pens, brochures, rate cards, event calendars, etc.**



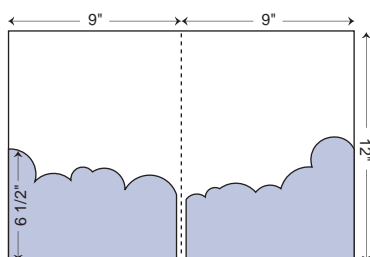
LS2628

- Pockets are glued
- Closing flap tucks into slit on front
- See page 42 for pocket slit options
- Call for pricing on final folding



SS2112

- Pockets are glued
- City scape die cut pockets
- Pocket slits standard as shown
- **Ideal for real estate, city or chamber of commerce, travel folders, etc.**



LS3193

- Pockets are glued
- Scalloped pockets
- See page 42 for pocket slit options



Legal Folders

Mortgage documents, title insurance policies, wills, estate plans, trust documents, closing statements, and real estate documents are just some of the common uses for our Legal Folders. You will find our Legal Folders are designed to secure important papers with several pocket configurations and reinforcements.



Cost Per Each	250	500	1M	1500	2M	2500	3M	4M	5M	10M
Printed 1 color, 1 side	2.34	2.03	1.50	1.31	1.25	1.18	1.15	1.08	1.03	.86
Printed 2 colors, 1 side	3.16	2.64	1.82	1.56	1.43	1.32	1.27	1.18	1.08	.90
Printed 4 color process, 1 side	7.60	4.24	2.63	2.12	1.86	1.70	1.60	1.41	1.34	1.03
Foil stamped 1 color (24 sq. in.)	2.84	2.20	1.70	1.52	1.41	1.34	1.30	1.23	1.18	.99
Emboss (24 sq. in.)	2.98	2.28	1.74	1.54	1.43	1.35	1.31	1.24	1.19	1.01
Add To Base	250	500	1M	1500	2M	2500	3M	4M	5M	10M
Additional print	+.53	+.30	+.19	+.15	+.13	+.12	+.10	+.09	+.08	+.06
Additional foil	+.65	+.37	+.23	+.19	+.17	+.15	+.14	+.11	+.10	+.07
Additional emboss	+.65	+.37	+.23	+.19	+.17	+.15	+.14	+.11	+.10	+.07
Additional varnish/aqueous	+.75	+.39	+.22	+.17	+.14	+.12	+.11	+.10	+.09	+.07
Heavy ink coverage	+.75	+.39	+.22	+.17	+.14	+.12	+.11	+.10	+.09	+.07
Deluxe paper stock	+.20	+.16	+.15	+.15	+.15	+.15	+.15	+.15	+.15	+.15
Premium paper stock	+.47	+.40	+.36	+.36	+.36	+.36	+.36	+.36	+.36	+.36
Deduct From Base	250	500	1M	1500	2M	2500	3M	4M	5M	10M
Value paper stock	-.15	-.12	-.11	-.11	-.11	-.11	-.11	-.11	-.11	-.11

List prices effective January 2005

FOB: Wisconsin, Class P

Production Notes

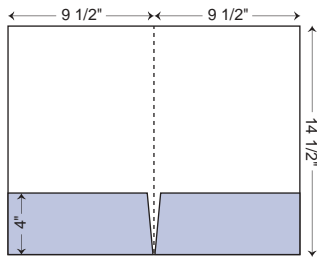
Important Information: please refer to pages 42 through 44 for all relevant information regarding the production of your order.

Pricing: established using base stocks. Refer to the "Stock Selection Guide" or see page 41.

Production Time: 7 working days on all Legal Folder styles, after all items are received; with credit and proof approval. Orders in by 1PM CST will be considered day one. Multiple processes will require additional working days.

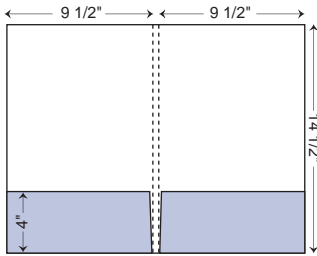
Stock: all stock groups are available for this style. However, 10 pt. stocks are not recommended.

Legal Folders



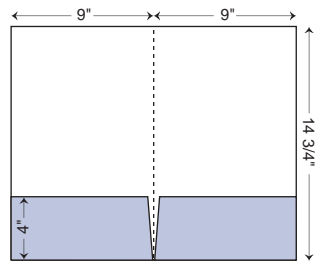
LS124

- Pockets are glued
- See page 42 for pocket slit options



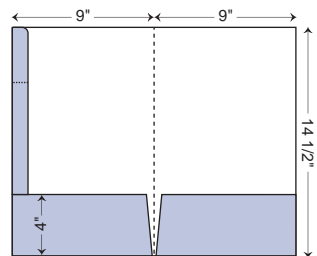
LS2559

- Pockets are glued
- 3/8" backbone provides additional capacity
- See page 42 for pocket slit options



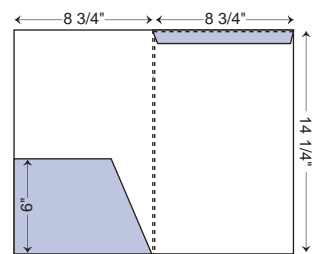
LS325

- Pockets are glued
- See page 42 for pocket slit options



LS2533

- Pockets are glued
- 1" reinforced unglued tab on left with 3 1/2" perf tab at top
- See page 42 for pocket slit options
- Call for pricing on final folding
- **Ideal for filing**



LS819

- Pocket is glued
- 1/8" backbone provides additional capacity
- 3/4" tab with 1/8" expansion to staple documents under
- See page 42 for pocket slit options
- Call for pricing on final folding



Mini Folders

Showcase your products and services with these Mini Folders! Many customers use them for new member packets, new patient kits, benefits packets and new client folders. Use them with inserts providing information about your services, hours of operation, policies, qualifications, etc. These Mini Folders also work great as ticket and receipt holders.



Cost Per Each	250	500	1M	1500	2M	2500	3M	4M	5M	10M
Printed 1 color, 1 side	1.93	1.14	.78	.68	.63	.61	.56	.50	.46	.29
Printed 2 colors, 1 side	2.68	1.49	.99	.83	.74	.69	.65	.59	.54	.35
Printed 4 color process, 1 side	5.33	3.03	1.84	1.39	1.19	1.13	.95	.81	.73	.48
Foil stamped 1 color (24 sq. in.)	2.22	1.54	.89	.76	.70	.67	.63	.57	.52	.33
Emboss (24 sq. in.)	2.36	1.61	.92	.79	.72	.69	.64	.58	.52	.33
Add To Base	250	500	1M	1500	2M	2500	3M	4M	5M	10M
Additional print	+.53	+.30	+.19	+.15	+.13	+.12	+.10	+.09	+.08	+.06
Additional foil	+.65	+.37	+.23	+.19	+.17	+.15	+.14	+.11	+.10	+.07
Additional emboss	+.65	+.37	+.23	+.19	+.17	+.15	+.14	+.11	+.10	+.07
Additional varnish/aqueous	+.75	+.39	+.22	+.17	+.14	+.12	+.11	+.10	+.09	+.07
Heavy ink coverage	+.75	+.39	+.22	+.17	+.14	+.12	+.11	+.10	+.09	+.07
Additional charge - select styles	+.29	+.27	+.22	+.22	+.22	+.21	+.21	+.21	+.21	+.16
Deluxe paper stock	+.10	+.08	+.08	+.08	+.08	+.08	+.08	+.08	+.08	+.08
Premium paper stock	+.25	+.20	+.19	+.19	+.18	+.18	+.18	+.18	+.18	+.18
Deduct From Base	250	500	1M	1500	2M	2500	3M	4M	5M	10M
Value paper stock	-.08	-.06	-.06	-.06	-.06	-.06	-.06	-.06	-.06	-.06

List prices effective January 2005

FOB: Wisconsin, Class P

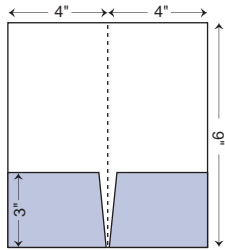
Production Notes

Important Information: please refer to pages 42 through 44 for all relevant information regarding the production of your order.

Pricing: established using base stocks. Refer to the "Stock Selection Guide" or see page 41.

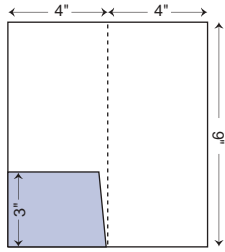
Production Time: 7 working days on all Mini Folder styles, after all items are received; with credit and proof approval. Orders in by 1PM CST will be considered day one. Multiple processes will require additional working days.

Mini Folders



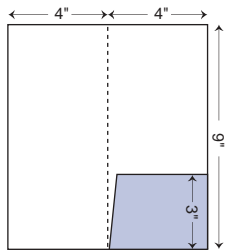
MM74

- Pockets are glued
- See page 42 for pocket slit options
- **Ideal for #10 envelope**



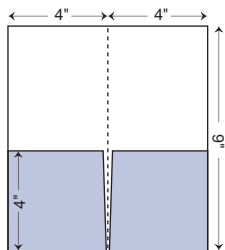
MM74LP

- Pocket is glued
- See page 42 for pocket slit options
- **Ideal for #10 envelope**



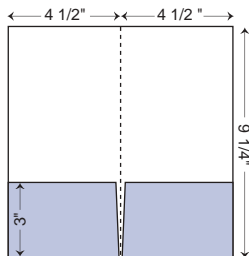
MM74RP

- Pocket is glued
- See page 42 for pocket slit options
- **Ideal for #10 envelope**



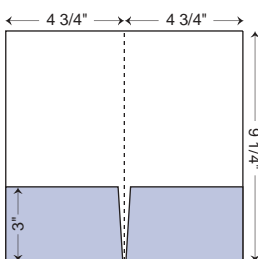
MM829

- Pockets are glued
- See page 42 for pocket slit options
- **Ideal for #10 envelope**



MM293

- Pockets are glued
- See page 42 for pocket slit options

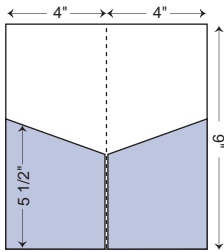


MM594

- Pockets are glued
- See page 42 for pocket slit options

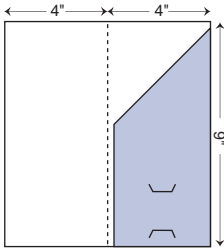


Mini Folders



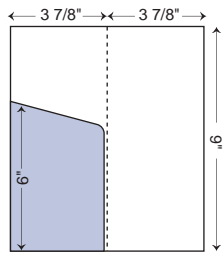
F1035

- Pockets are glued
- 5 1/2" pockets angle down to 4"
- See page 42 for pocket slit options



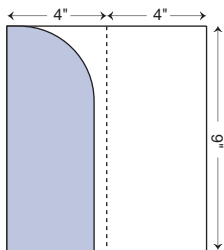
V853

- Pocket is glued
- 8 1/2" pocket angles down to 4 3/4"
- Pocket slits standard as shown



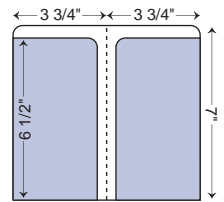
V2039

- Pocket is glued
- 6" pocket angles down to 5"
- See page 42 for pocket slit options



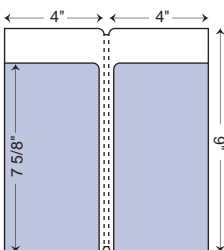
V1144

- Pocket is glued
- See page 42 for pocket slit options
- Tall pocket secures documents



VDRC-2

- Pockets are glued
- Pocket slits not available

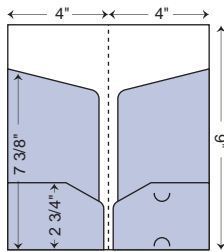


F1082

- Pockets are glued
- 3/16" backbone provides additional capacity
- See page 42 for pocket slit options
- Call for pricing on final folding

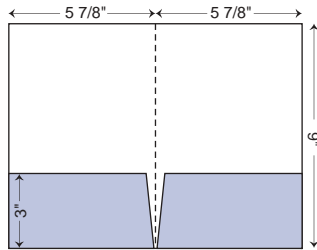


Mini Folders



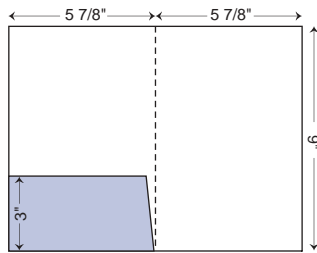
F419

- Pockets are glued
- Pocket slits standard as shown
- See price chart for additional charges
- Call for pricing on final folding
- **Ideal for holding tickets or receipts**



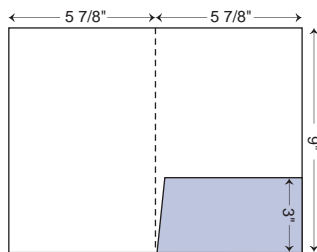
SS607

- Pockets are glued
- See page 42 for pocket slit options
- See price chart for additional charges



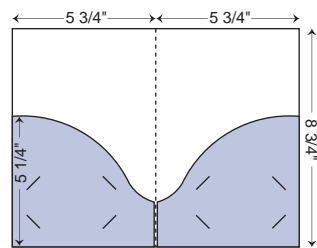
SS607LP

- Pocket is glued
- See page 42 for pocket slit options
- See price chart for additional charges



SS607RP

- Pocket is glued
- See page 42 for pocket slit options
- See price chart for additional charges



SS3375

- Pockets are glued
- Pocket slits are standard as shown
- See price chart for additional charges



Hotel Key Folders

Welcome guests to your hotel, conference center, casino or resort with these Hotel Key Folders. Highlight the amenities of your facility, entice guests to use on premise or off-premise services or offer coupons to attractions using these folders. These folders provide a perfect marketing opportunity to increase repeat guests, enhance revenues per stay, and increase loyalty for overall occupancy gains!



Cost Per Each	5M	10M	15M	20M	25M	50M	100M
Printed 1 color, 1 side	.28	.22	.20	.19	.18	.14	.12
Printed 2 colors, 1 side	.34	.25	.21	.20	.19	.15	.13
Printed 4 color process, 1 side	.50	.33	.27	.24	.23	.20	.18
Foil stamped 1 color (24 sq. in.)	.31	.24	.20	.19	.18	.14	.12
Emboss (24 sq. in.)	.31	.24	.20	.19	.18	.14	.12
Add To Base	5M	10M	15M	20M	25M	50M	100M
Additional print	+.05	+.03	+.02	+.02	+.02	+.01	+.01
Additional charge - select styles	+.17	+.16	+.15	+.14	+.14	+.14	+.14

List prices effective January 2005

FOB: Wisconsin, Class P

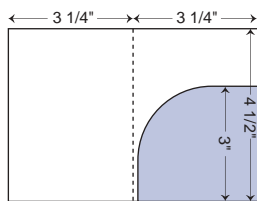
Production Notes

Important Information: please refer to pages 42 through 44 for all relevant information regarding the production of your order.

Pricing: established using base stocks. Refer to the "Stock Selection Guide" or see page 41.

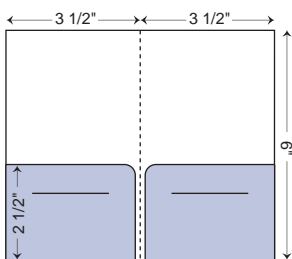
Production Time: 7-10 working days on all Hotel Key Folder styles, after all items are received; with credit and proof approval. Orders in by 1PM CST will be considered day one. Multiple processes will require additional working days.

Stock: Hotel Key Folders are priced using 67# White Vellum Cover Stock. Please call for stock samples. All other stock groups are available for this style and require an estimate.



KC850

- Pocket is glued
- See page 42 for pocket slit options

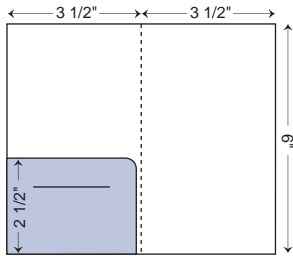


KC748

- Pockets are glued
- Pocket slits standard as shown
- Two key slits designed for multiple occupancy

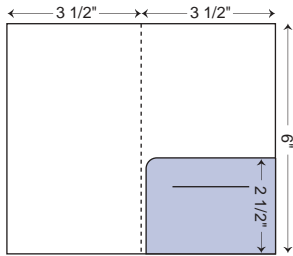


Hotel Key Folders



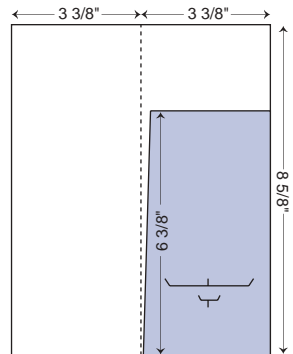
KC748LP

- Pocket is glued
- Pocket slit standard as shown



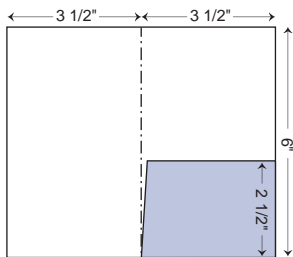
KC748RP

- Pocket is glued
- Pocket slit standard as shown



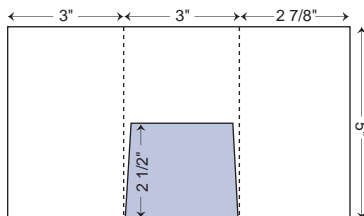
KC3127

- Pocket is glued
- Pocket slits standard as shown
- See price chart for additional charges



KC2484

- Pocket is glued
- Pocket slits not available
- Center score is perforated
- **Ideal for coupon or special offer**



KC3389

- Pocket is unglued
- Pocket slits not available
- See price chart for additional charges
- Call for pricing on final folding



Report Covers

Our report covers are designed to support your professional communication goals.

Cost Per Each	250	500	1M	1500	2M	2500	3M	4M	5M
Printed 1 color, 1 side	1.29	.79	.52	.46	.42	.40	.39	.36	.34
Printed 2 colors, 1 side	1.87	1.16	.70	.62	.56	.51	.50	.47	.43
Printed 4 color process, 1 side	6.12	3.31	1.91	1.51	1.29	1.20	1.11	.99	.92
Foil stamped 1 color (24 sq. in.)	1.97	1.22	.82	.71	.67	.62	.61	.58	.56
Emboss (24 sq. in.)	2.11	1.29	.85	.73	.69	.64	.62	.59	.57
Add To Base	250	500	1M	1500	2M	2500	3M	4M	5M
Additional print	+.53	+.30	+.19	+.15	+.13	+.12	+.10	+.09	+.08
Additional foil	+.65	+.37	+.23	+.19	+.17	+.15	+.14	+.11	+.10
Additional emboss	+.65	+.37	+.23	+.19	+.17	+.15	+.14	+.11	+.10
Additional charge - EE100, EE101	+.16	+.13	+.12	+.12	+.12	+.12	+.12	+.12	+.12
Plastic binding strips	+.31	+.31	+.31	+.31	+.31	+.31	+.31	+.31	+.31
Deluxe paper stock	+.10	+.08	+.08	+.08	+.08	+.08	+.08	+.08	+.08
Premium paper stock	+.25	+.20	+.19	+.19	+.18	+.18	+.18	+.18	+.18
Deduct From Base	250	500	1M	1500	2M	2500	3M	4M	5M
Value paper stock	-.08	-.06	-.06	-.06	-.06	-.06	-.06	-.06	-.06

List prices effective January 2005

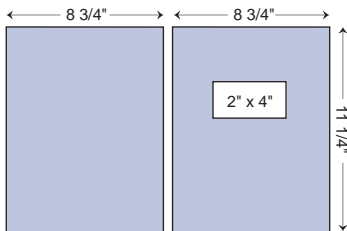
FOB: Wisconsin, Class P

Production Notes

Important Information: please refer to pages 42 through 44 for all relevant information regarding the production of your order.

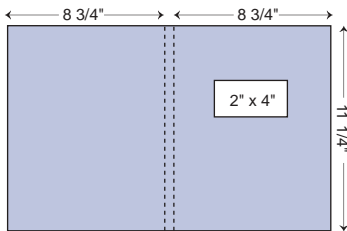
Pricing: established using base stocks. Refer to the "Stock Selection Guide" or see page 41.

Production Time: 7 working days on all Report Cover styles, after all items are received; with credit and proof approval. Orders in by 1PM CST will be considered day one. Multiple processes will require additional working days.



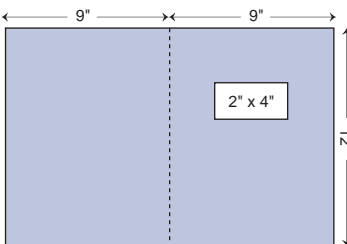
EE102

- Window diecut standard as shown
- Available with or without window
- Optional round corners on window
- Plastic binding strips available



EE100

- Window diecut standard as shown
- Available with or without window
- Optional round corners on window
- 1/2" backbone provides additional capacity
- Call for pricing on final folding
- See price chart for additional charges



EE101

- Window diecut standard as shown
- Available with or without window
- Optional round corners on window
- Call for pricing on final folding
- See price chart for additional charges



Tax Folders

You're an expert at preparing tax returns and assisting your clients in planning for and minimizing their tax burden. Shouldn't the folder you use reflect your credentials?

Cost Per Each	250	500	1M	1500	2M	2500	3M	4M	5M
Printed 1 color, 1 side	2.14	1.56	1.24	1.07	.98	.93	.89	.84	.81
Printed 2 colors, 1 side	2.78	1.85	1.38	1.21	1.12	1.05	1.01	.95	.92
Foil stamped 1 color (24 sq. in.)	2.41	1.71	1.34	1.18	1.10	1.05	1.01	.96	.93
Emboss (24 sq. in.)	2.55	1.78	1.38	1.20	1.12	1.08	1.02	.97	.94
Add To Base	250	500	1M	1500	2M	2500	3M	4M	5M
Additional print	+.53	+.30	+.19	+.15	+.13	+.12	+.10	+.09	+.08
Additional foil	+.65	+.37	+.23	+.19	+.17	+.15	+.14	+.11	+.10
Additional emboss	+.65	+.37	+.23	+.19	+.17	+.15	+.14	+.11	+.10
Deluxe paper stock	+.19	+.15	+.14	+.14	+.14	+.14	+.14	+.14	+.14
Premium paper stock	+.45	+.38	+.34	+.33	+.33	+.33	+.33	+.33	+.33
Deduct From Base	250	500	1M	1500	2M	2500	3M	4M	5M
Value paper stock	-.14	-.12	-.11	-.10	-.10	-.10	-.10	-.10	-.10

List prices effective January 2005

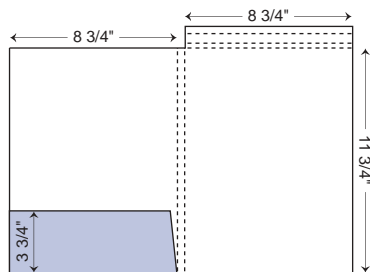
FOB: Wisconsin, Class P

Production Notes

Important Information: please refer to pages 42 through 44 for all relevant information regarding the production of your order.

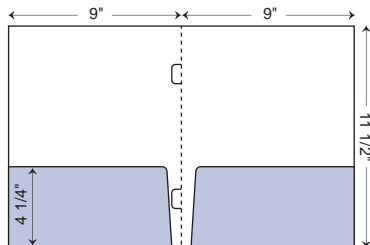
Pricing: established using base stocks. Refer to the "Stock Selection Guide" or see page 41.

Production Time: 7 working days on all Tax Folder styles, after all items are received; with credit and proof approval. Orders in by 1PM CST will be considered day one. Multiple processes will require additional working days.



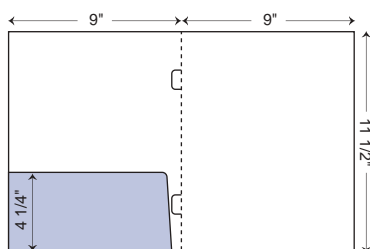
SS1228

- Pocket is glued
- 3/8" backbone provides additional capacity
- See page 42 for pocket slit options
- Call for pricing on final folding
- Document tab conceals staples



SS1170

- Pockets are glued
- Tabs for stapling in tax returns
- See page 42 for pocket slit options



SS1170LP

- Pocket is glued
- Tabs for stapling in tax returns
- See page 42 for pocket slit options



File Folders

Imagine the possibilities using these File Folders to create, maintain and support your image. These file folders will ensure your materials are kept in the prominent place they were intended for. Many organizations use them for personnel programs, child safety programs, warranty materials, tax organizers, customer information and policy packages just to name a few of the many uses.



Cost Per Each	250	500	1M	1500	2M	2500	3M	4M	5M	10M
Printed 1 color, 1 side	1.73	1.19	.82	.72	.68	.64	.62	.59	.51	.39
Printed 2 colors, 1 side	2.16	1.59	1.05	.87	.74	.68	.65	.61	.55	.41
Add To Base	250	500	1M	1500	2M	2500	3M	4M	5M	10M
Additional print	+.53	+.30	+.19	+.15	+.13	+.12	+.10	+.09	+.08	+.07
2" metal fasteners	+.50	+.50	+.50	+.50	+.50	+.50	+.50	+.50	+.50	+.50
Base stock	+.15	+.13	+.12	+.12	+.12	+.12	+.12	+.12	+.12	+.12
Deluxe paper stock	+.19	+.15	+.14	+.14	+.14	+.14	+.14	+.14	+.14	+.14
Premium paper stock	+.45	+.38	+.34	+.33	+.33	+.33	+.33	+.33	+.33	+.33
Additional charge - select styles	+.07	+.07	+.07	+.07	+.07	+.07	+.07	+.07	+.07	+.07

List prices effective January 2005

FOB: Wisconsin, Class P

Production Notes

Important Information: please refer to pages 42 through 44 for all relevant information regarding the production of your order.

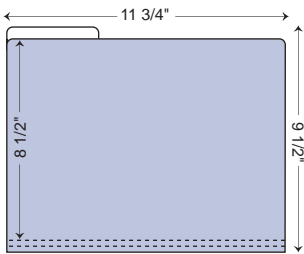
Pricing: established using value stocks. Refer to the "Stock Selection Guide" or see page 41.

Production Time: 7 working days on all File Folder styles, after all items are received; with credit and proof approval. Orders in by 1PM CST will be considered day one. Multiple processes will require additional working days.

2" Metal Fasteners: These self-sticking fasteners bond to folders. Extra production time is required.

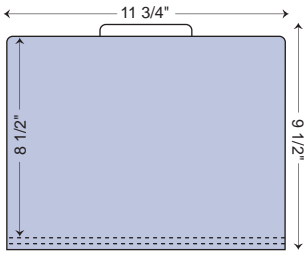


File Folders



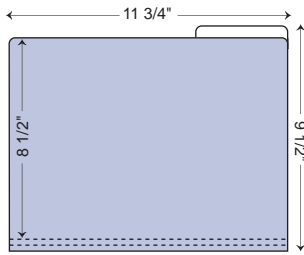
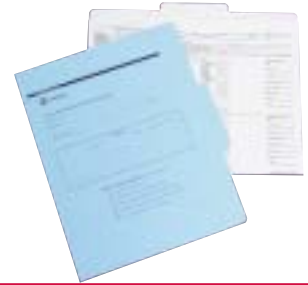
FS214

- Two 1/4" scores on front panel
- 1/2" tab extension
- 3 7/8" tab length in first position
- Call for pricing on final folding



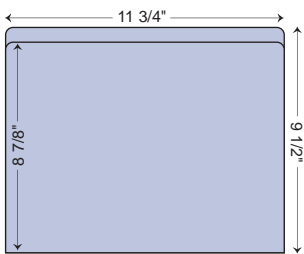
FS213

- Two 1/4" scores on front panel
- 1/2" tab extension
- 3 7/8" tab length in second position
- Call for pricing on final folding



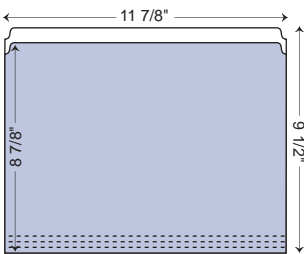
FS212

- Two 1/4" scores on front panel
- 1/2" tab extension
- 3 7/8" tab length in third position
- Call for pricing on final folding



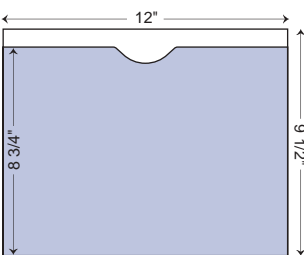
FS2793

- Full tab with double thick reinforcement
- 5/8" tab extension
- See price chart for additional charges
- Call for pricing on final folding



FS2038

- Full tab
- 1/2" tab extension
- Three 1/4" scores on front panel
- Call for pricing on final folding

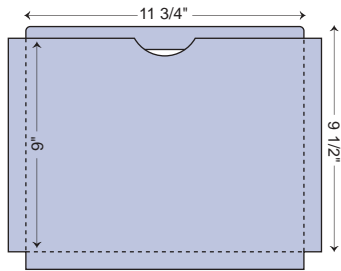


FS958

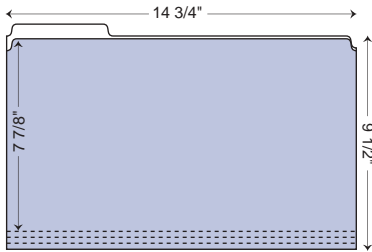
- Glued edges
- Thumb cut for easy document removal
- See price chart for additional charges



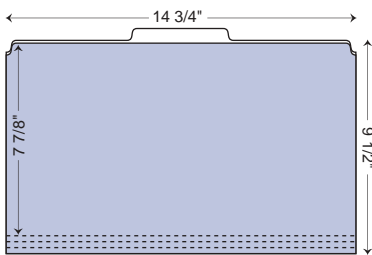
File Folders



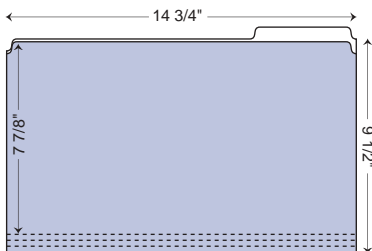
- FS3153**
- Full tab with double thick reinforcement
 - 1/2" tab extension
 - Glued edges
 - Expands to 1 1/2"
 - Call for pricing



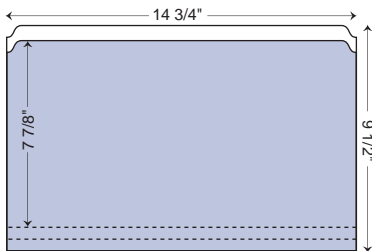
- FS1847**
- Three 1/4" scores on front panel
 - 1/2" tab extension
 - 4" tab length in first position
 - See price chart for additional charges
 - Call for pricing on final folding



- FS1848**
- Three 1/4" scores on front panel
 - 1/2" tab extension
 - 4" tab length in second position
 - See price chart for additional charges
 - Call for pricing on final folding



- FS1849**
- Three 1/4" scores on front panel
 - 1/2" tab extension
 - 4" tab length in third position
 - See price chart for additional charges
 - Call for pricing on final folding



- FS988**
- Two 1/2" scores on front panel
 - Full tab with 5/8" extension
 - See price chart for additional charges
 - Call for pricing on final folding



Paper Wallets

Use these Paper Wallets for automobile purchase papers, insurance papers, credit union papers, loan documents, automobile repair shop records, wills, trust papers, motorsports papers (i.e. motorcycle, snowmobile, ATV, boating, RV, etc.), and the list goes on. Your clients and customers will appreciate the professional manner in which you present your materials to them and you'll build loyalty!

Cost Per Each	250	500	1M	1500	2M	2500	3M	4M	5M	10M
Printed 1 color, 1 side	1.56	1.02	.64	.52	.44	.40	.38	.36	.34	.30
Printed 2 colors, 1 side	2.19	1.48	.98	.78	.62	.54	.47	.44	.40	.32
Printed 4 color process, 1 side	4.89	3.32	1.82	1.28	1.19	1.13	.90	.68	.60	.44
Foil stamped 1 color (24 sq. in.)	1.90	1.28	.81	.66	.60	.58	.54	.49	.46	.39
Emboss (24 sq. in.)	2.03	1.34	.84	.69	.62	.59	.55	.50	.46	.39
Add To Base	250	500	1M	1500	2M	2500	3M	4M	5M	10M
Additional print	+.53	+.30	+.19	+.15	+.13	+.12	+.10	+.09	+.08	+.06
Additional foil	+.65	+.37	+.23	+.19	+.17	+.15	+.14	+.11	+.10	+.07
Additional emboss	+.65	+.37	+.23	+.19	+.17	+.15	+.14	+.11	+.10	+.07
Additional charge - expandable styles	+1.01	+.81	+.63	+.53	+.50	+.49	+.47	+.45	+.44	+.38
White velcro dot closures	+.50	+.50	+.50	+.50	+.50	+.50	+.50	+.50	+.50	+.50
White velcro dot to strip closures (up to 2" expansion with 1 dot)	+.72	+.72	+.72	+.72	+.72	+.72	+.72	+.72	+.72	+.72
Black elastic bands with barb closure (die cut hole on flap, bands not attached)	+.24	+.24	+.24	+.24	+.24	+.24	+.24	+.24	+.24	+.24
Black elastic bands with barb closure (metal eyelet on flap, bands not attached)	+.60	+.60	+.60	+.60	+.60	+.60	+.60	+.60	+.60	+.60
Deluxe paper stock	+.19	+.15	+.14	+.14	+.14	+.14	+.14	+.14	+.14	+.14
Premium paper stock	+.45	+.38	+.34	+.33	+.33	+.33	+.33	+.33	+.33	+.33
Deduct From Base	250	500	1M	1500	2M	2500	3M	4M	5M	10M
Value paper stock	-.14	-.12	-.11	-.10	-.10	-.10	-.10	-.10	-.10	-.10

List prices effective January 2005

FOB: Wisconsin, Class P

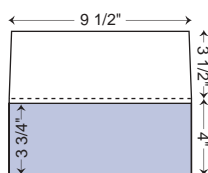
Production Notes

Final Folding: Call for pricing on final folding on all Paper Wallet styles.

Important Information: please refer to pages 42 through 44 for all relevant information regarding the production of your order.

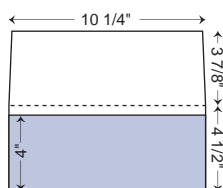
Pricing: established using base stocks. Refer to the "Stock Selection Guide" or see page 41.

Production Time: 7 working days on all Paper Wallet styles, after all items are received; with credit and proof approval. Orders in by 1PM CST will be considered day one. Multiple processes will require additional working days.



W170

- 4" x 9 1/2" closed
- **Ideal for storing important papers**

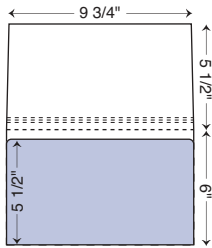


W38

- 4 1/2" x 10 1/4" closed
- **Ideal for storing important papers**

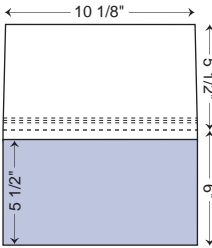


Paper Wallets



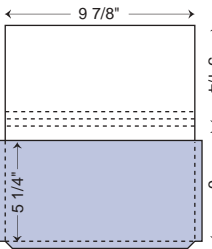
W101

- Three 1/8" scores to allow expansion
- 6" x 9 3/4" closed



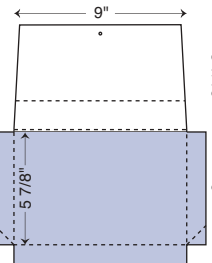
W2178

- Three 1/8" scores to allow expansion
- 6" x 10 1/8" closed



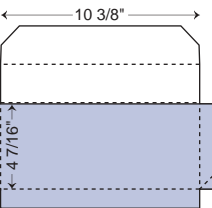
W638

- Three 3/8" scores to allow expansion
- Pocket expands to 3/4"
- 6" x 9 7/8" closed
- See price chart for additional charges



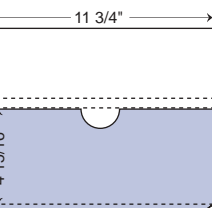
W2432

- Pocket expands to 2"
- 6" x 9" closed
- See price chart for additional charges



W125

- Pocket expands to 2"
- 4 1/2" x 10 3/8" closed
- See price chart for additional charges



W181

- Pocket expands to 1 1/8"
- 5" x 11 3/4" closed
- See price chart for additional charges



Portfolios

Use these portfolios for everything from world-class real estate development papers, to insurance program materials, to new member packets, to new employee packages and everything imaginable in between. You'll be able to package volumes of information, communicate your message and maintain your image – all of which are crucial to long-term success. Be confident in our portfolios as the perfect solution for your image and packaging needs.



Cost Per Each	250	500	1M	1500	2M	2500	3M	4M	5M	10M
Printed 1 color, 1 side	2.43	1.94	1.44	1.16	1.04	.98	.94	.88	.84	.76
Printed 2 colors, 1 side	3.02	2.52	1.72	1.36	1.20	1.10	1.04	.96	.90	.80
Printed 4 color process, 1 side	7.25	4.02	2.60	1.90	1.68	1.44	1.34	1.22	1.14	.92
Foil stamped 1 color (24 sq. in.)	2.76	2.04	1.56	1.28	1.18	1.12	1.09	1.04	1.02	.88
Emboss (24 sq. in.)	2.91	2.11	1.60	1.30	1.20	1.13	1.10	1.05	1.03	.88
Add To Base	250	500	1M	1500	2M	2500	3M	4M	5M	10M
Additional print	+.53	+.30	+.19	+.15	+.13	+.12	+.10	+.09	+.08	+.06
Additional foil	+.65	+.37	+.23	+.19	+.17	+.15	+.14	+.11	+.10	+.07
Additional emboss	+.65	+.37	+.23	+.19	+.17	+.15	+.14	+.11	+.10	+.07
Additional varnish/aqueous	+.75	+.39	+.22	+.17	+.14	+.12	+.11	+.10	+.09	+.07
Heavy ink coverage	+.75	+.39	+.22	+.17	+.14	+.12	+.11	+.10	+.09	+.07
Additional charge - expandable styles	+1.17	+.95	+.77	+.67	+.63	+.57	+.55	+.53	+.51	+.49
White velcro dot closures	+.50	+.50	+.50	+.50	+.50	+.50	+.50	+.50	+.50	+.50
White velcro dot to strip closures (up to 2" expansion with 1 dot)	+.72	+.72	+.72	+.72	+.72	+.72	+.72	+.72	+.72	+.72
Black elastic bands with barb closure (die cut hole on flap, bands not attached)	+.24	+.24	+.24	+.24	+.24	+.24	+.24	+.24	+.24	+.24
Black elastic bands with barb closure (metal eyelet on flap, bands not attached)	+.60	+.60	+.60	+.60	+.60	+.60	+.60	+.60	+.60	+.60
Deluxe paper stock	+.20	+.16	+.15	+.15	+.15	+.15	+.15	+.15	+.15	+.15
Premium paper stock	+.47	+.40	+.36	+.36	+.36	+.36	+.36	+.36	+.36	+.36
Deduct From Base	250	500	1M	1500	2M	2500	3M	4M	5M	10M
Value paper stock	-.15	-.12	-.11	-.11	-.11	-.11	-.11	-.11	-.11	-.11

List prices effective January 2005

FOB: Wisconsin, Class P

Production Notes

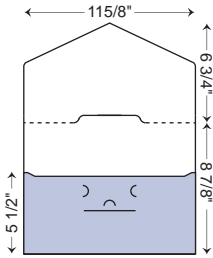
Final Folding: Call for pricing on final folding on all Portfolio styles.

Important Information: please refer to pages 42 through 44 for all relevant information regarding the production of your order.

Pricing: established using base stocks. Refer to the "Stock Selection Guide" or see page 41.

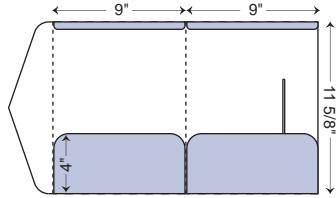
Production Time: 10 working days on all Portfolio styles, after all items are received; with credit and proof approval. Orders in by 1PM CST will be considered day one. Multiple processes will require additional working days.

Portfolios



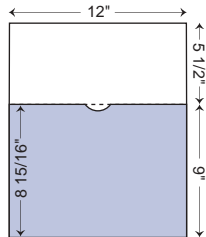
DD1617

- Pocket is glued
- Pocket slits standard as shown
- 1/2" tab extension when folded
- 4" tab length
- Flap tucks into slit on pocket
- 8 7/8" x 11 5/8" closed



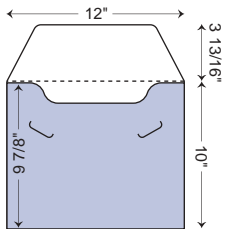
W3023

- Pockets are unglued
- Two 1/2" flaps at top to hold your documents in place
- Closing flap tucks into slit on front
- 11 5/8" x 9" closed



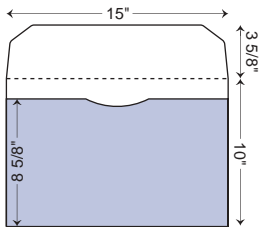
W1219

- Thumb cut for easy document removal
- 9" x 12" closed



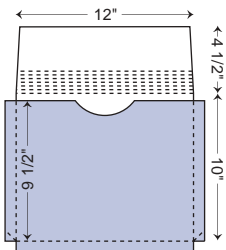
W2587

- Flap tucks into slits in pocket
- 10" x 12" closed



W1005

- 10" x 15" closed
- Oversized for legal documents

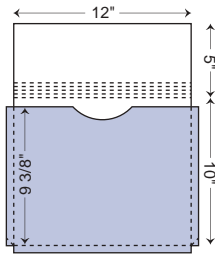


W1285

- Multiple scores to allow expansion
- Pocket expands to 1/2"
- 10" x 12" closed
- See price chart for additional charges

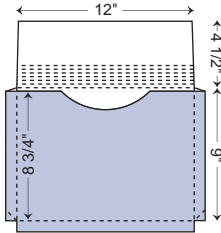


Portfolios



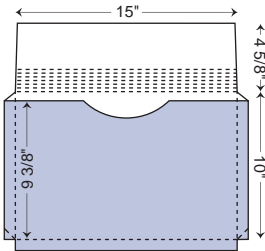
W1878

- Multiple scores to allow expansion
- Pocket expands to 1"
- 10" x 12" closed
- See price chart for additional charges



W1419

- Multiple scores to allow expansion
- Pocket expands to 1 1/2"
- 9" x 12" closed
- See price chart for additional charges



WL2739

- Multiple scores to allow expansion
- Pocket expands to 1 1/2"
- 10" x 15" closed
- See price chart for additional charges



Inserts

Throughout this catalog you have seen a wide representation of solutions we've helped produce for customers just like you. Our catalog proudly displays the largest assortment of standard Presentation Folder and Promotional Packaging designs found in a single catalog. But did you also know we've helped customers with the inserts they place in their folders? Pictured here you'll find examples of just a few of the stepped inserts and stitched brochures manufactured in our facility. All done to the same exacting standards you'll find through our entire product line. Please call customer service if we can help with inserts for your next order.

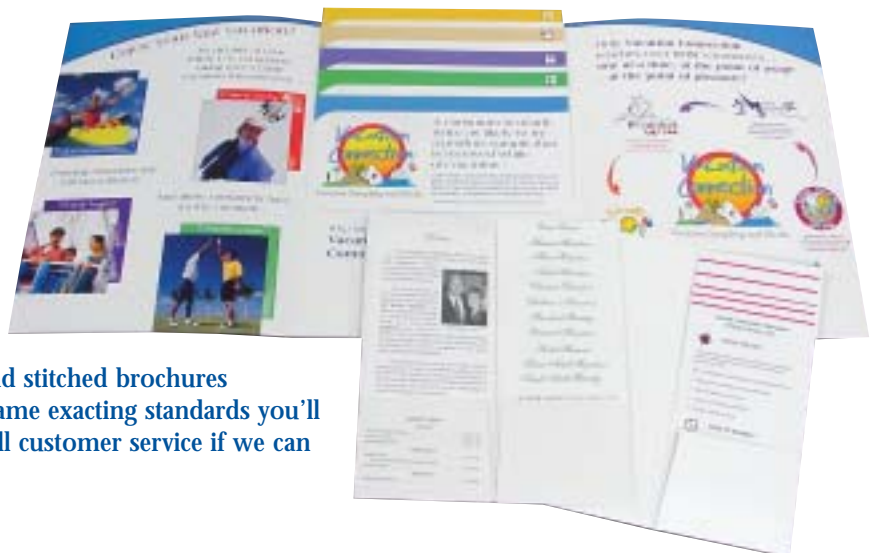


Photo Frames

Cost Per Each	250	500	1M	1500	2M	2500	3M	4M	5M
Printed 1 color, 1 side	2.07	1.41	1.12	1.04	.74	.66	.60	.58	.56
Printed 2 colors, 1 side	2.80	1.83	1.40	1.25	.87	.76	.73	.71	.69
Printed 4 color process, 1 side	3.98	3.40	2.22	1.80	1.34	1.27	1.21	1.19	1.17
Foil stamped 1 color (24 sq. in.)	2.53	1.83	1.44	1.29	.95	.86	.80	.78	.76
Emboss (24 sq. in.)	2.66	1.89	1.48	1.31	.97	.87	.81	.79	.79
Add To Base	250	500	1M	1500	2M	2500	3M	4M	5M
Additional print	+.53	+.30	+.19	+.15	+.13	+.12	+.10	+.09	+.08
Additional foil	+.65	+.37	+.23	+.19	+.17	+.15	+.14	+.11	+.10
Additional emboss	+.65	+.37	+.23	+.19	+.17	+.15	+.14	+.11	+.10
Additional varnish/aqueous	+.75	+.39	+.22	+.17	+.14	+.12	+.11	+.10	+.09
Additional charge - PF57H & PF57V	+.32	+.32	+.32	+.32	+.32	+.32	+.32	+.32	+.32
Additional charge - PF810H & PF810V	+.63	+.63	+.63	+.63	+.63	+.63	+.63	+.63	+.63
Deluxe paper stock	+.19	+.15	+.14	+.14	+.14	+.14	+.14	+.14	+.14
Premium paper stock	+.45	+.38	+.34	+.33	+.33	+.33	+.33	+.33	+.33
Deduct From Base	250	500	1M	1500	2M	2500	3M	4M	5M
Value paper stock	-.14	-.12	-.11	-.10	-.10	-.10	-.10	-.10	-.10

List prices effective January 2005

FOB: Wisconsin, Class P

Production Notes

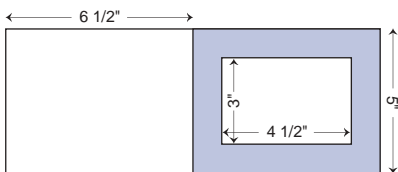
Final Folding: Call for pricing on final folding on all Photo Frame styles.

Important Information: please refer to pages 42 through 44 for all relevant information regarding the production of your order.

Pricing: established using base stocks. Refer to the "Stock Selection Guide" or see page 41.

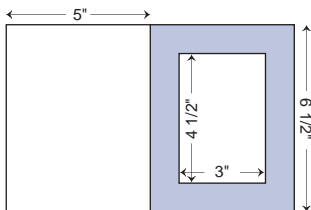
Production Time: 7 working days on all Photo Frame styles, after all items are received; with credit and proof approval. Orders in by 1PM CST will be considered day one. Multiple processes will require additional working days.

Stock: all stock groups are available for this style. However, 10 pt. stocks and 65# cover weight stocks are not recommended.



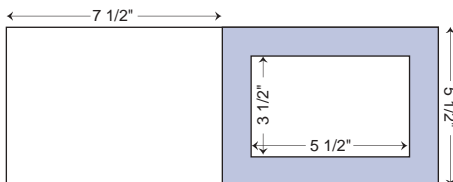
PF35H

- Holds a 3 1/2" x 5" horizontal photo
- Photo inserts from the left
- **Ideal for promotions**



PF35V

- Holds a 3 1/2" x 5" vertical photo
- Photo inserts from the left

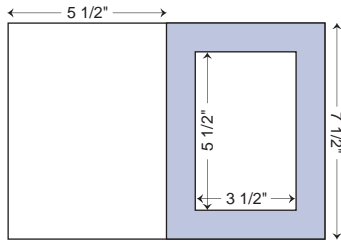


PF46H

- Holds a 4" x 6" horizontal photo
- Photo inserts from the left

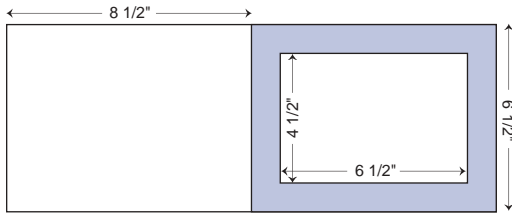


Photo Frames



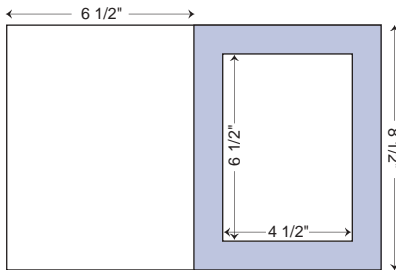
PF46V

- Holds a 4" x 6" vertical photo
- Photo inserts from the left
- **Ideal for real estate development**



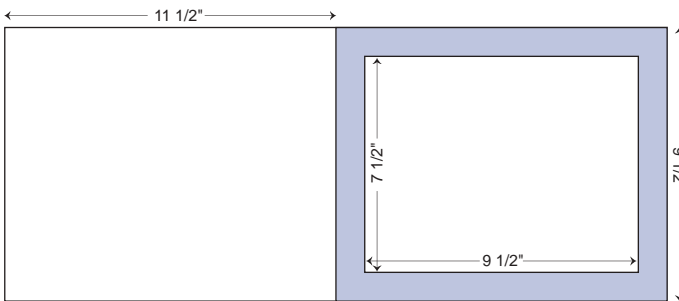
PF57H

- Holds a 5" x 7" horizontal photo
- Photo inserts from the left
- See price chart for additional charges



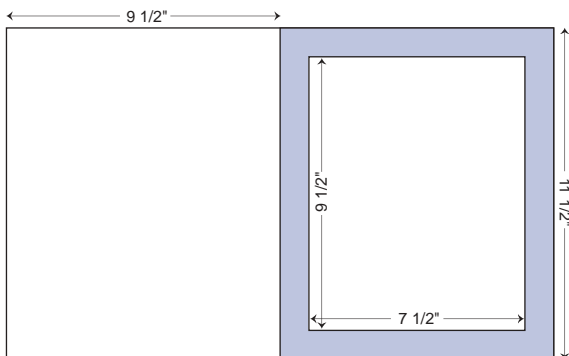
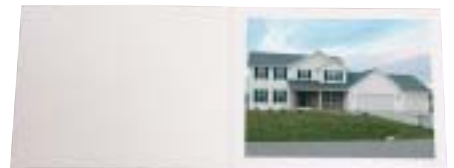
PF57V

- Holds a 5" x 7" vertical photo
- Photo inserts from the left
- See price chart for additional charges



PF810H

- Holds an 8" x 10" horizontal photo
- Photo inserts from the left
- See price chart for additional charges



PF810V

- Holds an 8" x 10" vertical photo
- Photo inserts from the left
- See price chart for additional charges



Certificate Holders

Recognize attendees of your conference or seminar by presenting them with a certificate in one of these professional Certificate Holders. Also great for employee recognition.

Cost Per Each	250	500	1M	1500	2M	2500	3M	4M	5M	10M
Printed 1 color, 1 side	2.10	1.46	1.10	.98	.91	.86	.84	.82	.79	.65
Printed 2 colors, 1 side	2.80	1.80	1.32	1.18	1.10	1.00	.96	.92	.90	.74
Printed 4 color process, 1 side	5.90	3.84	2.34	1.80	1.34	1.16	1.14	1.12	1.08	.98
Foil stamped 1 color (24 sq. in.)	2.55	1.73	1.31	1.17	1.13	1.06	1.04	1.02	.98	.88
Emboss (24 sq. in.)	2.69	1.80	1.34	1.19	1.15	1.07	1.05	1.03	.99	.89
Add To Base	250	500	1M	1500	2M	2500	3M	4M	5M	10M
Additional print	+.53	+.30	+.19	+.15	+.13	+.12	+.10	+.09	+.08	+.06
Additional foil	+.65	+.37	+.23	+.19	+.17	+.15	+.14	+.11	+.10	+.07
Additional emboss	+.65	+.37	+.23	+.19	+.17	+.15	+.14	+.11	+.10	+.07
Additional varnish/aqueous	+.75	+.39	+.22	+.17	+.14	+.12	+.11	+.10	+.09	+.07
Deluxe paper stock	+.19	+.15	+.14	+.14	+.14	+.14	+.14	+.14	+.14	+.14
Premium paper stock	+.45	+.38	+.34	+.33	+.33	+.33	+.33	+.33	+.33	+.33
Deduct From Base	250	500	1M	1500	2M	2500	3M	4M	5M	10M
Value paper stock	-.14	-.12	-.11	-.10	-.10	-.10	-.10	-.10	-.10	-.10

List prices effective January 2005

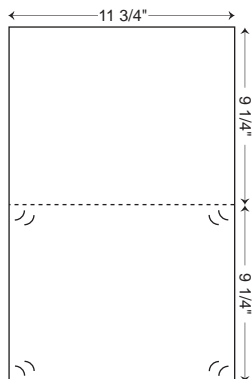
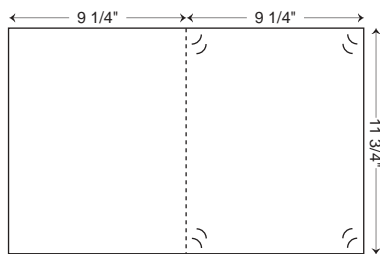
FOB: Wisconsin, Class P

Production Notes

Important Information: please refer to pages 42 through 44 for all relevant information regarding the production of your order.

Pricing: established using base stocks. Refer to the "Stock Selection Guide" or see page 41.

Production Time: 7 working days on all Certificate Holder styles, after all items are received; with credit and proof approval. Orders in by 1PM CST will be considered day one. Multiple processes will require additional working days.



CH810HV

- Holds an 8" x 10" or 8 1/2" x 11" certificate horizontally or vertically
- Certificate slits standard as shown



CD and DVD

You invested heavily to make sure the contents on your CD or DVD are first class, but now you need packaging that tells the world that your contents demand their attention. Use any of these CD or DVD styles to sell your product, provide instructions to users, include brochures and user guides, or for mailing your media. This packaging will help you make a great first time impression and then your CD or DVD can make that lasting impression.



Cost Per Each	250	500	1M	1500	2M	2500	3M	4M	5M	10M
Printed 1 color, 1 side	2.56	1.72	1.06	.88	.76	.72	.67	.62	.60	.54
Printed 2 colors, 1 side	3.20	2.04	1.30	1.06	.94	.84	.78	.70	.66	.63
Printed 4 color process, 1 side	5.21	4.06	2.28	1.68	1.40	1.13	1.05	.96	.88	.80
Add To Base	250	500	1M	1500	2M	2500	3M	4M	5M	10M
Additional print	+.53	+.30	+.19	+.15	+.13	+.12	+.10	+.09	+.08	+.07
Additional varnish/aqueous	+.75	+.39	+.22	+.17	+.14	+.12	+.11	+.10	+.09	+.07
Heavy ink coverage	+.75	+.39	+.22	+.17	+.14	+.12	+.11	+.10	+.09	+.07
Packaging stock	+.14	+.12	+.11	+.10	+.10	+.10	+.10	+.10	+.10	+.10
Additional charge - select styles	+.80	+.76	+.72	+.66	+.60	+.54	+.48	+.42	+.37	+.30
Deduct From Base	250	500	1M	1500	2M	2500	3M	4M	5M	10M
Reduced charge - select styles	-.22	-.20	-.18	-.16	-.15	-.14	-.13	-.12	-.10	-.08

List prices effective January 2005

FOB: Wisconsin, Class P

Production Notes

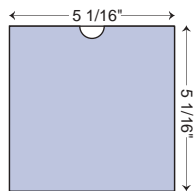
Final Folding: Call for pricing on final folding on all CD and DVD styles.

Important Information: please refer to pages 42 through 44 for all relevant information regarding the production of your order.

Pricing: established using value stocks. Refer to the "Stock Selection Guide" or see page 41.

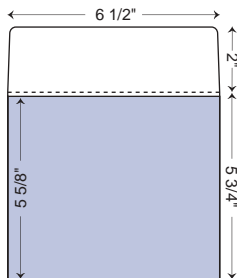
Production Time: 10 working days on all CD or DVD styles, after all items are received; with credit and proof approval. Orders in by 1PM CST will be considered day one. Multiple processes will require additional working days.

CD and DVD



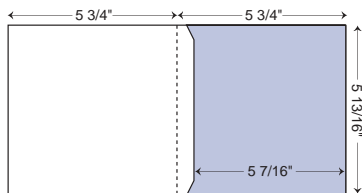
C3079

- Sleeve with thumb cut on one side
- See price chart for deduction



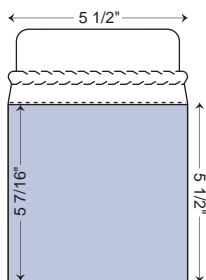
C1871

- See price chart for deduction



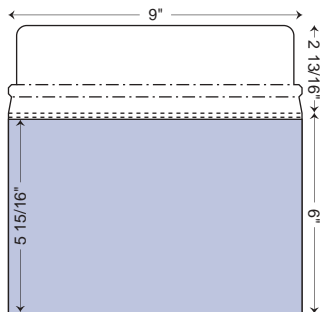
C1088

- Sleeve with full flap.
- Die cut for easy CD or DVD removal
- See price chart for deduction



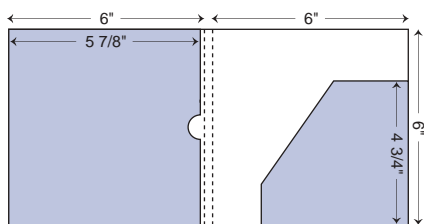
C2773

- Includes double stick tape
- Perf-off strip on flap for easy opening
- **Ideal as a mailer**



C1399

- Includes double stick tape
- Perf-off strip on flap for easy opening
- **Ideal as a mailer**

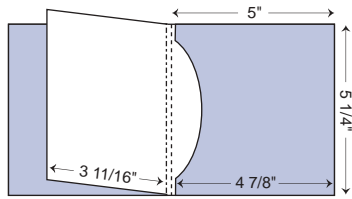


C2996

- Oversized to hold larger booklets and brochures
- Thumb cut for easy CD or DVD removal
- 1/4" backbone provides additional capacity
- See price chart for additional charges

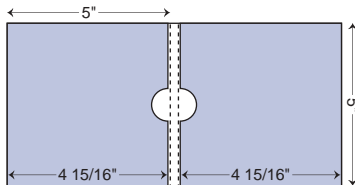


CD and DVD



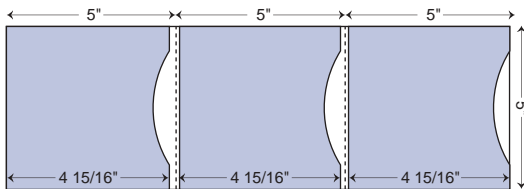
C3062

- Two pockets
- Right pocket has deep thumb cut for easy CD or DVD removal
- Perf-off on left panel
- See price chart for additional charges



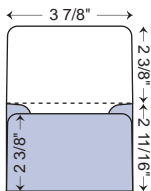
C2597

- Thumb cuts for easy CD or DVD removal
- 1/4" backbone provides additional capacity
- See price chart for additional charges
- **Ideal for including information booklets**



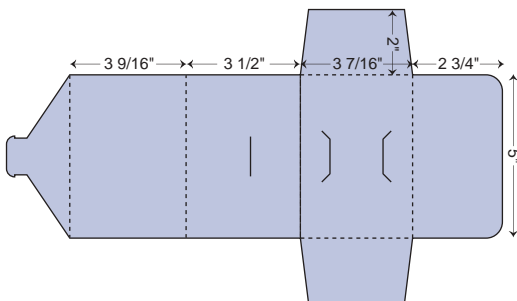
C2288

- Holds 3 CD's or DVD's
- Closes to 5" x 5"
- See price chart for additional charges



C2387

- For digital business cards
- Pocket is glued
- **Ideal for ID or membership cards, ATM cards, credit or gift cards, phone cards, etc.**



C3162

- For digital business cards
- Tabs wrap around and lock in the slit to make a secure closure
- **Ideal for self promotion**



No more scrambling or fumbling for something to put your proposals in. You'll find a host of ideas on every page. So take your time and browse every page to find the perfect idea. Or use the Table of Contents to help you find the products you're looking for in a hurry!

Promotional Packaging

Give your marketing campaign that extra boost that assures it of success! Use any of the Promotional Packaging designs on these pages to send your efforts soaring to the top. Many customers use these packages to include Ad Specialty items as part of an overall communications program, for customer appreciation events, for seminars, for parties, and for souvenirs. In fact this is a perfect area to dream...dream in color or add foil stamping for a little extra splash!

Cost Per Each	250	500	1M	1500	2M	2500	3M	4M	5M	10M
Printed 1 color, 1 side	2.41	1.49	1.04	.90	.84	.73	.69	.65	.61	.53
Printed 2 colors, 1 side	3.02	1.75	1.20	1.00	.94	.84	.80	.69	.65	.57
Printed 4 color process, 1 side	7.56	3.96	2.31	1.75	1.49	1.22	1.18	1.06	.88	.67
Foil stamped 1 color (24 sq. in.)	3.23	1.84	1.33	1.06	.96	.88	.84	.75	.71	.63
Add To Base	250	500	1M	1500	2M	2500	3M	4M	5M	10M
Additional print	+.53	+.30	+.19	+.15	+.13	+.12	+.10	+.09	+.08	+.06
Additional foil	+.65	+.37	+.24	+.19	+.17	+.15	+.14	+.11	+.10	+.08
Additional varnish/aqueous	+.75	+.39	+.22	+.17	+.14	+.12	+.11	+.10	+.09	+.07
Heavy ink coverage	+.75	+.39	+.22	+.17	+.14	+.12	+.11	+.10	+.09	+.07
Additional charge - select styles	+1.76	+1.28	+.85	+.82	+.79	+.76	+.72	+.69	+.65	+.62

List prices effective January 2005

FOB: Wisconsin, Class P

Production Notes

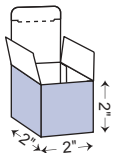
Final Folding: Promotional Packaging is shipped flat and is not available formed.

Important Information: please refer to pages 42 through 44 for all relevant information regarding the production of your order.

Pricing: established using packaging stocks. Refer to the "Stock Selection Guide" or see page 41.

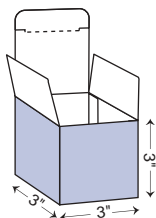
Production Time: 10 working days on all Promotional Packaging styles, after all items are received; with credit and proof approval. Orders in by 1PM CST will be considered day one. Multiple processes will require additional working days.

Stock: is limited to the Packaging Group of papers in our "Stock Selection Guide" and on page 41.



B2991

- Cube with tuck flap on top
- Interlocking bottom

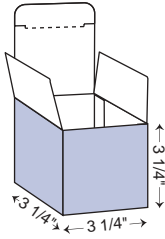


B1840

- Cube with tuck flap on top
- Interlocking bottom

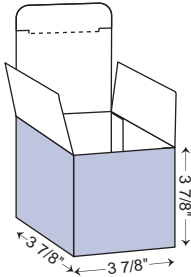


Promotional Packaging



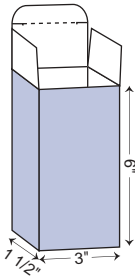
B1916

- Cube with tuck flap on top
- Interlocking bottom



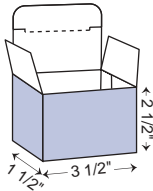
B1842

- Cube with tuck flap on top
- Interlocking bottom



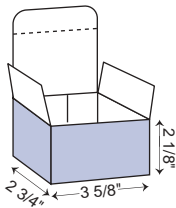
B3525

- Box with tuck flap on both ends



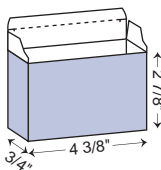
B1837

- Box with tuck flap on top
- Interlocking bottom



B2304

- Box with tuck flap on top
- Self-forming, no glue

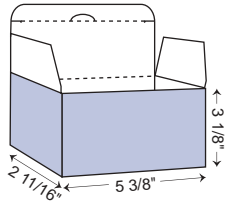


B1870

- Box with tuck flap on top
- Interlocking bottom

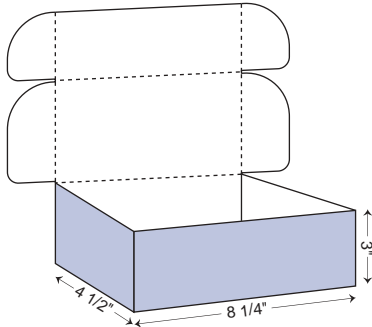


Promotional Packaging



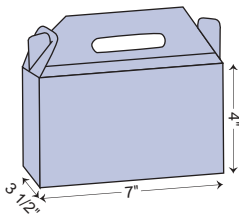
B3498

- Box with tuck flap on top and bottom
- Tab allows for easy opening



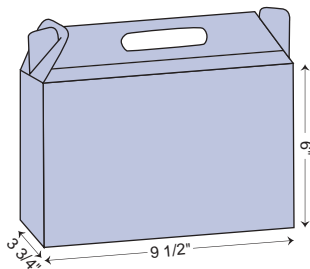
B3494

- Box with interlocking tabs on top
- Self-forming, no glue
- See price chart for additional charges



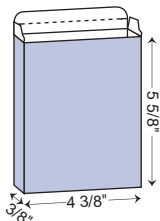
B3338

- Box with tuck flap on top and bottom
- Easy to carry with integrated handle
- See price chart for additional charges



B3339

- Box with tuck flap on top and bottom
- Optional notched horizontal pocket slits available on side panel
- See price chart for additional charges

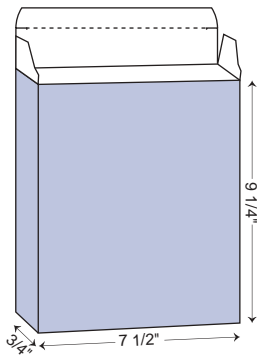


B2890

- Box with tuck flap on top and bottom
- **Ideal for schools and retail**

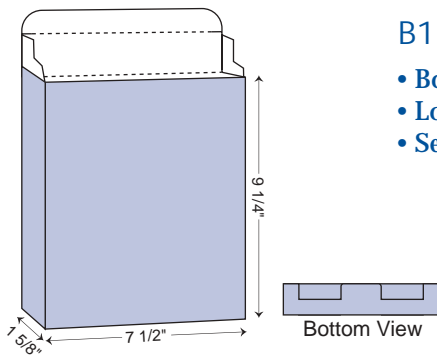


Promotional Packaging



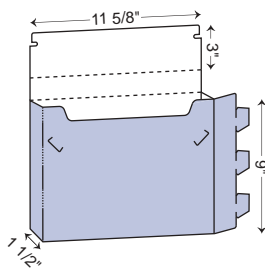
B1149

- Box with tuck flap on top and bottom
- See price chart for additional charges
- **Ideal for software**



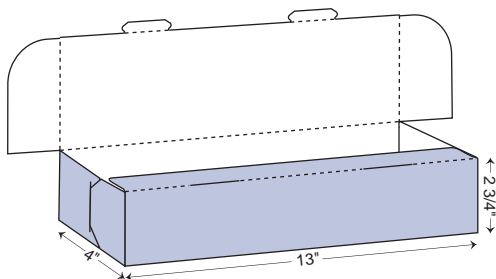
B1365

- Box with tuck flap on top
- Lock bottom closure as pictured below
- See price chart for additional charges



W3095

- Box with interlocking tabs on sides and top
- Self-forming, no glue
- See price chart for additional charges



B3518

- Box with interlocking tabs on sides and top
- Self-forming, no glue
- See price chart for additional charges



Custom Designs

Pictured on this page is just a small sampling of some of the stunning custom designs and product applications created by our customers. In each example you will find creativity being used to make an extraordinary application through a custom designed folder or promotional packaging idea. Let us make your presentation dreams a reality!



Financial Products

We are experts at supplying you with a variety of financial products.

Some of these products, which are pictured below, include:

Bank passbooks

Bank account registers

Checking/statement savings wallets

Vinyl business card holders

Vinyl CD holders

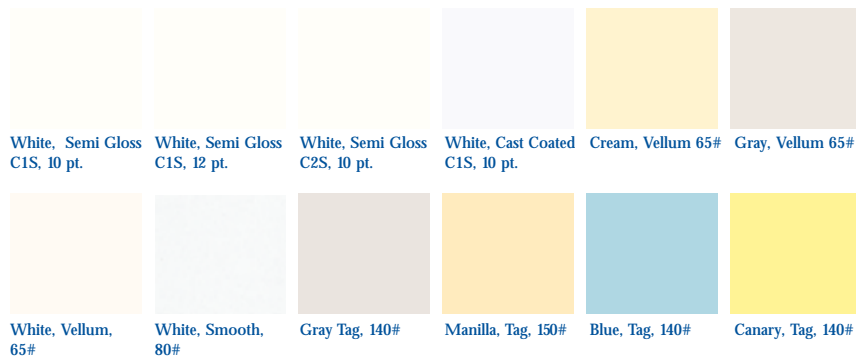
Vinyl passbook holders

Vinyl stock certificate holders.



Papers and Foils

Value Stocks



Base Stocks



Deluxe Stocks



Foil Colors

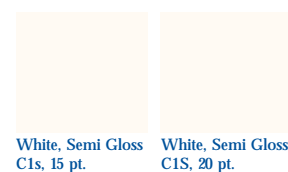
Metallic foils: Gold, Dull Gold, Silver, Platinum, Copper, Red, Burgundy, Green (medium), Electric Blue (medium), Sapphire Blue, Teal

Nonmetallic foils: Black, White, Cardinal (red), True Blue, Hunter Green, Ivory

Specialized foils: Pearl, Clear, Rainbow

Nonmetallic and specialized foils may appear a different shade of color when used on a darker paper stock and may not be completely opaque.

Packaging Stocks





Premium Stocks



The choices illustrated here are a representation of our paper stocks. The colors and textures you see are approximate and for use when a selection guide is not available. If you need exact stock finishes / colors or foil colors, please call customer service for samples.

Important Information

• **Artwork-Traditional:** This term refers to clean, black and white art (no photocopies or fax copies), color separated, sized to fit, mounted in position on art board and ready to be scanned. Copy should not be taped over or stapled. Copy that has rough edges or other imperfections will reproduce poorly. Any touch-ups or changes will incur additional charges. In preparing art for foil stamping and embossing avoid halftones, screens, tints, very fine lines (thinner than this ) and lines and letters placed very close together (closer than this ). **For screened areas, please provide electronic art.** When orders are manufactured to customer's specifications, the purchaser agrees to assume any liability resulting from actions or demands brought against the manufacturer for patent or copyright infringements.

• **Artwork - Electronic:** Our Electronic Prepress Services department saves and archives all electronic files for a 2 1/2 year period. When receiving your electronically scanned art files, we ask that the resolution be scanned at 300 dpi (dots per inch) or higher. Any disk manipulation will be charged at \$180 list (P) per hour. When submitting electronic artwork please refer to page 45, Preflight Checklist.

• **Changes or Cancellations:** Changes to orders in process may require additional charges. You will be billed for actual work performed on orders canceled in process. Minimum cancellation charge of \$60 list (P) applies. Custom stocks or materials will incur an additional restocking charge.

• **Coating – Aqueous/Varnish:** Used in conjunction with printing for special effect or to protect the product from scuffing. Varnish prices include an overall gloss varnish which is necessary with heavy ink coverage, inks containing reflex blue, large screened areas, and when using metallic inks. It may also be necessary on light coverage due to ink color and/or copy design. We will call and advise prior to production. Spot or matte varnish is also available for the same price. Either a protective gloss varnish or aqueous coating (at manufacturer's discretion) will be applied free of charge on all four-color process work.

• **Coating – Lamination:** Available in gloss or matte finish. Matte finish may show scuffing. Film lamination bonds a protective layer of plastic to the printed sheet. Lamination is the most durable of all coatings. Please call for pricing.

• **Coating – UV:** This coating is available in gloss finish, which is much more shiny than gloss varnish. Gloss UV Coating is applied to the sheet like a protective varnish, but dries to a brilliant shine when exposed to ultraviolet light. UV tends to show fingerprints on dark colors. Please call for pricing.

• **Credit Terms:** All orders subject to credit approval. Our standard terms are net 30 days from date of invoice after credit approval. After 30 days, our terms stipulate a service

charge of 1-1/2% of the unpaid balance per month commencing 30 days from date of invoice. In addition, if we must use legal services or suit to collect, our terms stipulate that collection fees and charges may be added to the original amount due us.

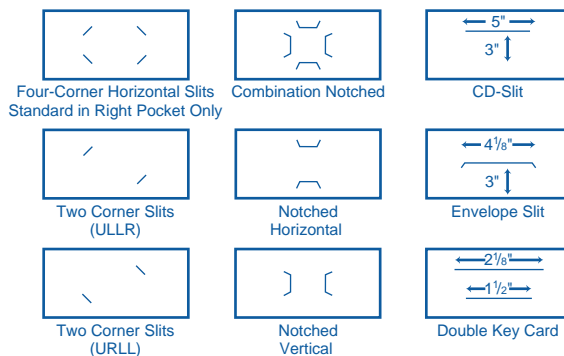
• **Custom Orders:** We would be happy to produce custom products for you. See page 40 for additional details and ideas. Please call for pricing.

• **Damaged Goods:** In case of damage or loss, make a notation on the bill of lading or delivery receipt. Cartons may be opened for inspection, **but the damaged merchandise and containers may not be disposed of.** A claim must be filed with the carrier within 10 days after receipt of merchandise. Please call us immediately if you have received damaged merchandise. **Please note:** All product lines that are converted with hot-melt adhesives are only warranted when the product is kept within a temperature between 35 degrees and 100 degrees Fahrenheit. This especially applies to warehouse storage.

• **Dealer Self-Promotion:** Please call Customer Service for details regarding discounts available on dealer self-promotion.

• **Delinquent Accounts:** If your account becomes delinquent, all orders will be placed on hold until payment in full is received. Delinquent accounts are reviewed and credit privileges may be decreased or revoked from those who repeatedly extend their payment beyond our terms of net 30 days. We reserve the right to grant or deny credit.

• **Die Cut Slits:** Four-corner horizontal slits are standard in the right pocket on many styles and will be used if none are specified. Four-corner horizontal slits may be deleted without charge if specified at the time your order is placed. Die cut slits, illustrated below, (other than the standard four-corner horizontal slits) incur an additional \$42 list charge (P).

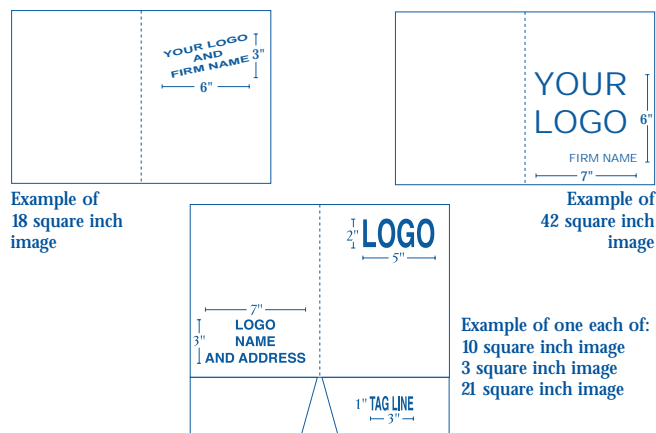


Limitations: For folders with 3" pockets use combination notched, notched horizontal, notched vertical or double key card slits. Double Key Card slits are the only optional pocket slits available for style KC850 hotel key folders. These slits are available as a custom die on other hotel key folders.

Important Information

• **Dies:** Foil stamping and embossing dies up to 24 continuous square inches are included in the pricing. For larger image areas, please call for a custom quote. Multi-level or sculpted embossed dies are made of brass which is not our standard die material. Call for pricing. Our foil and emboss dies are kept for 2 1/2 years. At that point, if we have not received a written request for return, materials are recycled.

The method illustrated below provides examples for calculating the overall image area or multiple areas for foil stamping or embossing.





• **Embossing:** Embossing prices include a single level embossing die up to 24 continuous square inches. Embossed images may be positioned anywhere on the front cover, but must remain 1/8" from all sides and may not bleed. When copy is embossed, it is raised to the maximum lift allowed by the die being used and the design; for example, fine-lined copy will limit height of embossing. Multi-level embossing and complex designs require an estimate.

• **Errors:** Check your order upon receipt. If you receive an order that is incorrect, please call us. Claims must be made within 30 days of receipt.

• **Estimates:** Provided upon request. Estimates are subject to receipt and approval of final art and specifications. Standard estimates will be provided at the time you call. Custom estimates are usually provided within 24 hours or less.

• **Final Folding:** your order will be shipped final folded unless otherwise specified at the time your order is placed. For select styles, which require an additional charge for final folding (as noted throughout the catalog), your order will ship flat unless quoted and specified as final folded at the time your order is placed. Promotional Packaging is shipped flat and is not available formed.

• **Foil Stamping:** Foil stamping prices include one foil stamping die and one standard foil color up to 24 continuous

square inches. Larger foil areas require additional die and foil charges, call for a quote. For best results, avoid type smaller than 10 pt.,* and avoid copy with tight, intricate detail which may fill in. Foil copy may be placed anywhere on the front cover, back cover and pockets but must remain 1/8" in from all edges and scores. *Halftones, screens, tints, very fine lines (thinner than this ) and lines and letters placed very close together (closer than this ) are not recommended.

• **Foil Colors:** See foil chart in the "Stock Selection Guide" or refer to page 41. Non-inventoried foils are available at an additional charge. Nonmetallic and pearlized foils may appear a different shade of color when used on a dark paper stock and may not be completely opaque.

• **Foil Stamping/Embossing Combinations:** There will be an additional charge to register foil or emboss. Please call for pricing.

• **Invoices and Samples:** Five samples of your order will be shipped to you. The invoice will be mailed separately. We can usually provide up to 10 custom samples free, if requested at time of order. Additional samples are billed at unit cost.

• **Overruns and Underruns:** Due to the number of production processes in the manufacture of your order, it is not possible to determine the exact quantity we will ship. All items in this catalog are subject to overruns and underruns of up to 10%, and will be billed on a prorata basis without prior notification. If an exact quantity is required, add 10% to catalog price.

• **Packaging:** Standard packaging consists of external corrugated boxes. Special packaging requests are subject to additional charges.

• **Prepayment Discount:** All orders prepaid in full when the order is placed will receive a 3% discount off the "per each total" (freight and all additional charges are not included). Full prepayment includes overrun, estimated freight and any additional charges.

• **Printing – Ink Colors:** PMS colors are available at no charge. Metallic, opaque and fluorescent PMS colors are available for \$130 list (P) per color. Fluorescent inks may require a second print run of the same color to achieve optimum color intensity. A color match is \$84 list (P). Ink colors lighter than the stock color are not recommended due to the translucent nature of offset inks.

• **Printing – Ink Coverage/Bleeds:** One-sided printing includes the front and back covers as well as printing on the pockets. Products are printed on offset presses and then die-cut to allow bleeds on all sides and any image placement. Price charts allow for line copy ink coverage with solids not to exceed 35% coverage. Heavy ink coverage (more than 35%

Important Information

coverage) can be calculated from the price list and may require a varnish or aqueous coating. Please call for a quote on jobs with flood coverage. Flood coverage includes any job that requires a second press pass plus varnish.

Printing – Four-Color Process: Four-color process prices include four process ink colors with printer supplying one contract color proof and one reader proof. We print 200 line screen for coated and uncoated stocks. For best reproduction of color, we suggest using a white stock. Please note: When process work involves an overall background color, which is produced using a combination screen, the results achieved for adjacent four-color process images may be affected. Best results are achieved by printing a separate spot color rather than attempting to achieve the desired color with a combination screen. Such orders involve additional costs. Please call for a cost estimate. Either a protective gloss varnish or aqueous coating (at manufacturer's discretion) will be applied free of charge on all four-color process work.

Production Time: Average production time varies, please check production information for each style. Items requiring special estimates vary in production time. Normal production days are Monday through Friday, excluding holidays. Please have your order and artwork in by 1PM CST for same day scheduling.

Promotion Rights: We reserve the right to use all products we produce in our advertising unless you specify otherwise, in writing, at the time you place your order.

Proofing Options: If a proof is required, your first fax, color ink-jet or PDF proof is FREE. Allow 2-3 working days to send a proof. Color proofs need to be returned. Any alterations in the copy made when the proof is returned that were not in the original copy will be billed as customer alterations. Normal production time begins after our receipt of approved proof.

Purchase Orders and Order Forms: All orders or reorders must be accompanied by a purchase order or an order form. We cannot process any orders without written authorization.

Registration: There is no extra charge for tight print registration in most cases. Additional charges apply for tight registration between printing, foil stamping and/or embossing. If there are additional charges, we will notify you before production.

Rush Orders: Many times we ship jobs early, however, if you need to guarantee early shipment, extra charges may apply. Expedited methods of shipping are additional and must be requested.

Sales Samples: We carry a wide variety of product style, paper stock, and image process samples and will be happy to

send them via ground shipping at no additional charge. We are also happy to ship overnight using your shipper number.

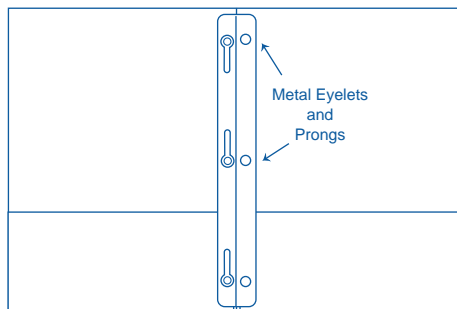
Shipping Information: All prices are FOB factory in Wisconsin. Unless otherwise specified, we normally ship ground inside the continental USA. If more economical on large shipments, motor freight will be used. If air shipment is desired, please let us know. If inside delivery (i.e. department, suite, floor) is required, please specify on your order.

Split Shipping Charges: \$30 list (P) per additional location over two.

Spine Elements: Available in white card stock. These may be added to the following style folders for an additional charge:

SS106	DD116	SS2900
SS106LP	SS973	SS171
SS106RP	SS1855	DD2669
SS1371	SS1572	DD314
SS1371LP	SS889	DD349
SS1371RP	SS1108	

Add 2-3 working days to the production time when adding spine elements.



Stock: Our inventoried stocks are shown in the "Stock Selection Guide" and on page 41. Custom stocks are also available, call us for pricing.

Typesetting: Our Electronic Prepress Services Department has a full library of Adobe Type Fonts. When sending us your typewritten copy, please specify which Adobe Font you would like us to print on your order. If you do not specify a font, additional charges will be incurred. You will also want to provide a complete product layout at the time you send in your order. Typesetting is available for an additional charge and requires a proof. Please call for pricing.

Preflight Checklist

Elements on a disk to be sent out should include:

- Page layout files.
- Live art files and scanned images. Don't forget embedded art files.
- Screen and printer fonts. Be sure to check all art files for fonts needed.
- Submit one of the following - a composite 100% size laser with color break marked - OR - a composite 100% size laser with individual lasers of each color separation plate attached.

If files are submitted via e-mail or FTP, please send along a PDF file of the project instead of hard copy.

Software Applications Supported

- QuarkXpress
- Adobe Illustrator
- Adobe Photoshop
- Adobe Pagemaker
- Adobe Acrobat (Acrobat PDF)
- Macromedia Freehand
- Adobe InDesign

Page layout issues:

- Page size should be defined as final trim size.
- All bleeds should be .125".
- Page/panel sizes should be correct for the style of fold, or see folder style illustration or dieline.
- Manufacturer will provide all trap.
- Clipping paths need to be created in Photoshop, avoid Quark clipping paths.

Type/Font issues:

- Avoid style options or buttons (choose a font from the font menu).
- Avoid specifying a rule weight of hairline (define it as a .25 point rule).

Color issues:

- Define color names exactly the same between graphics software and page layout programs.
- Define all colors appropriately and consistently as spot or CMYK in both graphics and page layout programs (CV, CVC, CVU).
- Output a laser copy of all separate color plates to verify accurate color break.
- When printing four-color process, add 30% magenta, 30% yellow and 60% cyan to the black in large solid black areas. (Rich Black - 30m30y60c100k)

Image considerations:

- Avoid placing PICT files. Convert them to EPS or TIFF format.
- Convert all live color bitmap files from RGB to CMYK.
- Ensure that scan resolutions are 300 dpi for images and 1200 dpi for scanned line work.
- If Quark pages are saved as EPS files and placed in another document, send the original Quark page and all placed files used to create the page.
- Place all scans at 100% size or smaller (enlargements may compromise quality).
- Rotate, scale, and crop all images before placing on page.
- Set picture box background color to NONE in Quark whenever possible.
- Create gradients (or blends) in Photoshop adding a gaussian noise of 2.
- Avoid saving screening information or transfer functions with Photoshop images.
- Clipping paths created in Photoshop need to be one full pixel into the image.

Scanning Available To Customers:

- Transparency, reflective color, black/white, line art, positive and negative copy for mats are accepted. Minimum reduction size is 10% and maximum enlargement size is 3000%.

Available Media:

- 100 and 250 mb Iomega Zip Drives
- CD ROM
- 1 and 2 GB Iomega Jaz Drives
- 3.5" Floppy Disk - Mac or PC
- LS-120 3.5" Drive - PC only

Methods of Electronic File Transfer:

Upload via website.

Go to: www.fsiproducts.com

Go to: File transfer options and click on: FTP through Web Link.

FTP Information:

Host: [ftp.independentinc.com](ftp://ftp.independentinc.com)

User Name: ipcuser

Password: indftp

E-mail Art to:

fsicomp@independentinc.com

